

edelux  
edelux

Qualität Innovation Design



# Innenräume Systeme

---



532



606



656

---

























# Innenräume

## Systeme

### Alphabetisches inhalt

Arca	534
Ego	548
Fluo	574
Linus	572
Office	588
Slot	598
Steel	584
Tesi	590
Vision	592

### Inhalt Typen

 <small>new</small>				
Arca Track <b>536</b>	Arca Accent <b>538</b>	Arca Wide <b>540</b>	Arca Pendant <b>542</b>	
 <small>new</small>	 <small>new</small>	 <small>new</small>	 <small>new</small>	 <small>new</small>
Ego Single <b>550</b>	Ego Double <b>554</b>	Ego Flat <b>556</b>	Ego Accent <b>558</b>	Ego Wide <b>560</b>
 <small>new</small>				
Ego Pendant <b>562</b>	Linus <b>572</b>	Fluo Accent <b>576</b>	Fluo Wide <b>578</b>	Fluo Biemission <b>580</b>
				
Steel Accent <b>584</b>	Steel Wide <b>584</b>	Office <b>588</b>		
 <small>new</small>				
Tesi <b>590</b>	Vision Trimless <b>594</b>	Vision Trim <b>596</b>		
 <small>new</small>				
Slot Recessed <b>600</b>	Slot Surface <b>602</b>	Slot Angular <b>604</b>		

# Arca **new**

Linearsystem aus extrudiertem Aluminium, kompatibel mit einer großen Auswahl von Beleuchtungselementen mit Sperrvorrichtung. Das System ist eloxiert und lackiert. Geeignet für Decke, Hängemontage oder randlosen Einbau in Gipskartondecken. Module nach gewünschter Anordnung kombinierbar. Die Track-Module sind ebenfalls in messing satiniert erhältlich. Querschnitt für Decken- und Pendelaufbau 42 mm Breite und 85 mm Höhe, Einbau 86 mm Breite und 90 mm Höhe. Beide Varianten sind in zwei Längen lieferbar: 1000mm und 3000 mm. Mit verschiedenen Lichtmodulen montierbar: WIDE-Modul verteilend, ACCENT-Modul mit UGR <13, TRACK, TRACK FLAT- oder PENDANT-Module für eine SPOT-Beleuchtung mit verschiedenen Ausstrahlwinkeln. Das CORNER-Modul für Eckkompositionen. LED integriert, lieferbar in den Lichtfarben 3000 K oder 4000 K; Binning initial  $\leq 3$ -Step MacAdam; Schutzklasse III; Lebensdauer LED 50.000h L70B50. Die 48Vdc-Versorgungsspannung ermöglicht vielfältige Anwendungen und Sicherheit, mit reversiblen und bei Bedarf veränderbaren Kompositionen. Geeignet für Räume, wo nach professioneller Beleuchtung mit minimalistischem Design gefragt wird, wie zum Beispiel BÜROS und GEWERBEFLÄCHEN.

**PRO** Hightech-Produkt mit hochwertigen Materialien, gedacht für einen professionellen Einsatz.

**UGR** Artikel mit UGR-Wert <13, <16 (Accent, Pendant).

Lichtquelle	LED COB /SMD
Transformator	No
inklusive	
Verfügbare	On/Off
Transformatore	
MacAdam	SDCM 3
CCT	3000K /4000K
CRI	$\geq 80$ / $\geq 90$
UGR	<13, <16 (Accent, Pendant)
LED Lebensdauer	50.000h
Schutzklasse	III
IP	20
Material	Aluminium
Garantie	5 Jahre





# Arca Track

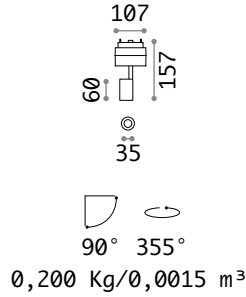

## LED SMD CREE

Leistung	Beam	Lumen	CCT	Ausführ.	Art-Nr.	€
5 W	34°	450 lm	3000 K	Schwarz	222974	109
				Messing	281995	109
		490 lm	4000 K	Schwarz	223056	109



## LENS

Erforderlich	Beam	Art-Nr.	€
Nein	20°	223087	8

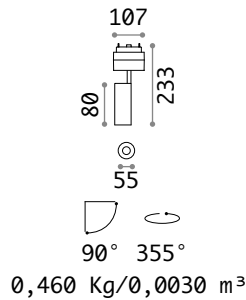

## LED COB CITIZEN

Leistung	Beam	Lumen	CCT	Ausführ.	Art-Nr.	€
14W	36°	1550 lm	3000 K	Schwarz	222967	140
				Messing	281988	140
		1650 lm	4000 K	Schwarz	223049	140



## LENS

Erforderlich	Beam	Art-Nr.	€
Nein	18°	223094	8

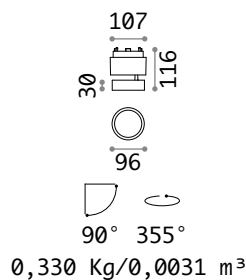

## LED COB CITIZEN CRI ≥ 90

Leistung	Beam	Lumen	CCT	Ausführ.	Art-Nr.	€
9 W	36°	1100 lm	3000 K	Schwarz	290621	140 <small>new</small>
				Messing	291536	140 <small>new</small>



Light beam: ACCENT

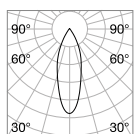

m	lx	øm
1	553	0,58
2	138	1,16
3	61	1,75
4	35	2,33
5	22	2,91



CRI ≥ 80 5,5W 34° 440lm 3000K

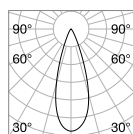

m	lx	øm
1	2336	0,60
2	584	1,21
3	259	1,81
4	146	2,42
5	93	3,02



CRI ≥ 80 14W 36° 1400lm 3000K

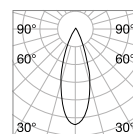

m	lx	øm
1	2242	0,60
2	560	1,20
3	249	1,80
4	140	2,40
5	90	3,00

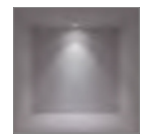

CRI ≥ 90 9W 36° 1100lm 3000K



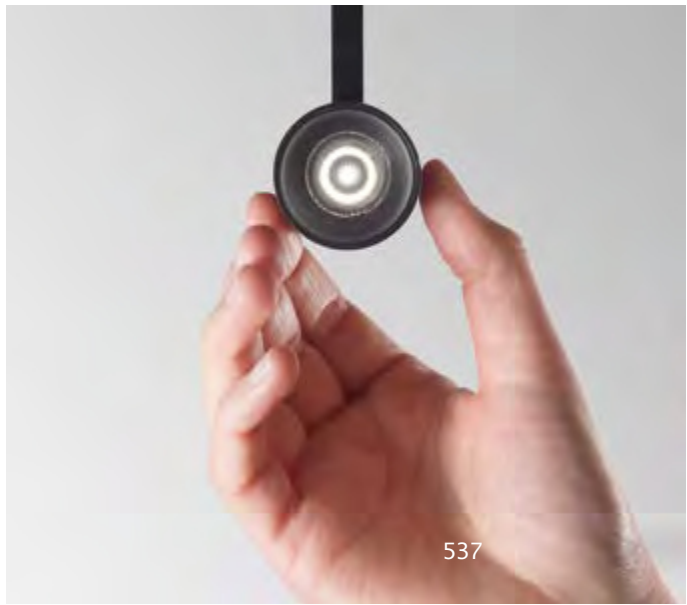

# Arca Accent

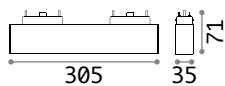

LED SMD OSRAM UGR <13

Leistung	Beam	Lumen	CCT	Ausführ.	Art-Nr.	€
15W	35°	2000 lm	3000 K	Schwarz	222929	170
		2100 lm	4000 K	Schwarz	223001	170

0,440 Kg/0,0026 m<sup>3</sup>

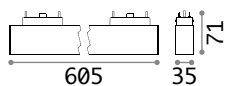

LED SMD OSRAM UGR <13

Leistung	Beam	Lumen	CCT	Ausführ.	Art-Nr.	€
29 W	35°	3650 lm	3000 K	Schwarz	222936	300
		3950 lm	4000 K	Schwarz	223018	300

0,700 Kg/0,0087 m<sup>3</sup>



Light beam: ACCENT

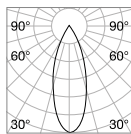

m	lx	Øm
1	2707	0,56
2	676	1,13
3	300	2,26
4	169	2,83
5	108	3,39

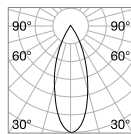
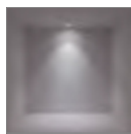

m	lx	Øm
1	4826	0,60
2	1207	1,21
3	536	1,81
4	301	2,42
5	193	3,02



CRI≥90 15W 35° 1700lm 3000K

CRI≥90 29W 35° 3200lm 3000K



Arca Accent 300 mm



Arca Accent 600 mm



# Arca Wide

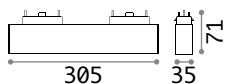
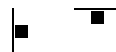

## LED SMD SAMSUNG

Leistung	Beam	Lumen	CCT	Ausführ.	Art-Nr.	€
13W	98°	1900 lm	3000 K	Schwarz	222943	105
		2000 lm	4000 K	Schwarz	223025	105

0,410 Kg/0,0025 m<sup>3</sup>

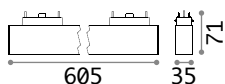

## LED SMD SAMSUNG

Leistung	Beam	Lumen	CCT	Ausführ.	Art-Nr.	€
25 W	98°	3800 lm	3000 K	Schwarz	222950	152
		4050 lm	4000 K	Schwarz	223032	152

0,700 Kg/0,0087 m<sup>3</sup>



Light beam: WIDE

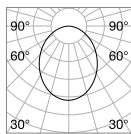

m	lx	øm
1	203	2,16
2	50	4,33
3	22	6,50
4	12	8,66
5	8	10,83

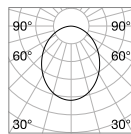
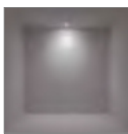

m	lx	øm
1	440	2,14
2	110	4,28
3	48	6,42
4	27	8,56
5	17	10,70



CRI≥80 13W 98° 1950lm 3000K

CRI≥80 25W 98° 4000lm 3000K



Arca Wide 300 mm



Arca Wide 600 mm



# Arca Pendant

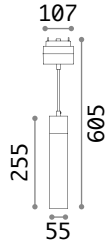

0,740 Kg/0,0056 m<sup>3</sup>

LED COB CITIZEN UGR <13

Leistung	Beam	Lumen	CCT	Ausführ.	Art.-Nr.	€
15W	34°	1550 lm	3000 K	Schwarz	222981	180
		1650 lm	4000 K	Schwarz	223063	180

Kabellänge 350 mm



LENS

Erforderlich	Beam	Art.-Nr.	€
Nein	18°	223285	8

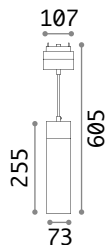

1,080 Kg/0,0056 m<sup>3</sup>

LED COB CITIZEN UGR <16

Leistung	Beam	Lumen	CCT	Ausführ.	Art.-Nr.	€
21W	30°	2100 lm	3000 K	Schwarz	222998	200
		2150 lm	4000 K	Schwarz	223070	200

Kabellänge 350 mm



LENS

Erforderlich	Beam	Art.-Nr.	€
Nein	15°	223292	8



Light beam: ACCENT

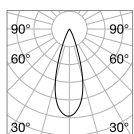

m	lx	øm
1	2410	0,59
2	602	1,19
3	268	1,78
4	151	2,38
5	96	2,98

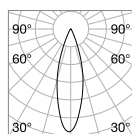

m	lx	øm
1	4788	0,51
2	1197	1,03
3	532	1,55
4	299	2,06
5	191	2,58



CRI≥80 15W 34° 1450lm 3000K

CRI≥80 21W 30° 2650lm 3000K



# Arca - Suspension

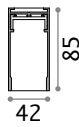
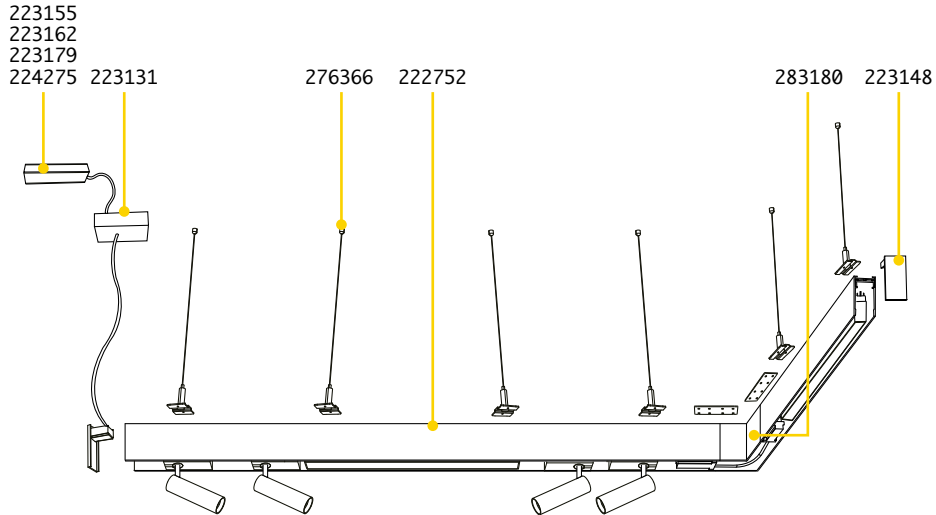

**TRACK** Max. Länge zu jedem Stromanschlusspunkt: 25 Meter

Länge	Gewicht	Volumen	Ausführ.	Art.-Nr.	€
1000 mm	1,34Kg	0,0273 m <sup>3</sup>	Schwarz	222745	120
3000 mm	4,02 Kg	0,0600 m <sup>3</sup>	Schwarz	222752	325

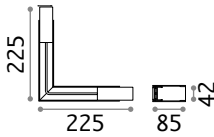

**BLINDED CORNER RIGHT-LEFT** Optionals

Gewicht	Volumen	Ausführ.	Art.-Nr.	€
0,79Kg	0,0090 m <sup>3</sup>	Schwarz	283180	120



	Erforderlich	Kabellänge	Maß (L x H x B)	Art.-Nr.	€
<b>LINEAR CONNECTOR</b>	Ja -1Kit x Verbindungselement		100x 18x 38 mm	254944	25
<b>ELECTRIFIED END CAP</b>	Ja -1Kit x Stromanschlussp. max 210W	2150 mm	100x 2270 x 53 mm	223131	39
<b>ENDCAP</b>	Ja		20 x 85 x 42 mm	223148	16
<b>SINGLE CABLE KIT</b>	Ja -1Kit x 1000mm	2000 mm	ø 15x 2000 mm	276366	13



# Arca – Surface

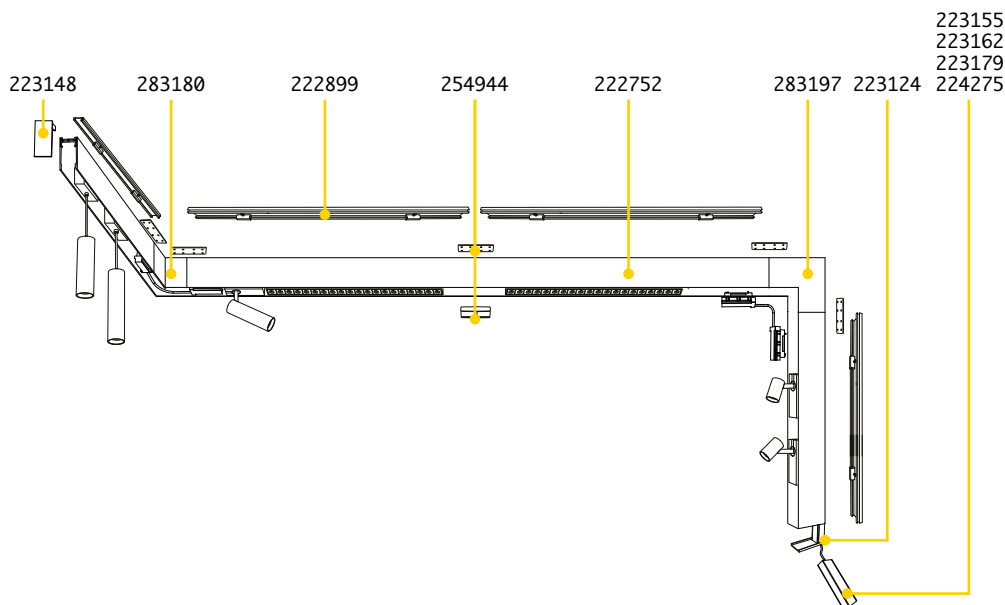

**TRACK** Max. Länge zu jedem Stromanschlusspunkt: 25 Meter

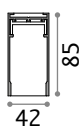

Länge	Gewicht	Volumen	Ausführ.	Art-Nr.	€
1000 mm	1,34Kg	0,0273 m <sup>3</sup>	Schwarz	222745	120
3000 mm	4,02 Kg	0,0600 m <sup>3</sup>	Schwarz	222752	325

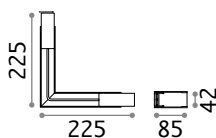

**BLINDED CORNER RIGHT-LEFT** Optionals

Gewicht	Volumen	Ausführ.	Art-Nr.	€
0,79Kg	0,0090 m <sup>3</sup>	Schwarz	283180	120

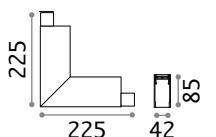

**BLINDED CORNER VERTICAL-HORIZONTAL** Optionals

Gewicht	Volumen	Ausführ.	Art-Nr.	€
0,79Kg	0,0090 m <sup>3</sup>	Schwarz	283197	120



**LINEAR CONNECTOR**

Erforderlich	Kabellänge	Maß (LxH xB)	Art-Nr.	€
Ja -1Kit x Verbindungselement		100 x 18 x 38 mm	254944	25

**ELECTRIFIED ENDCAP**

Ja -1Kit x Stromanschlussp. max 210W	380 mm	86 x 80 x 42 mm	223124	23
--------------------------------------	--------	-----------------	--------	----

**ENDCAP**

Ja		20 x 85 x 42 mm	223148	16
----	--	-----------------	--------	----

**KITSURFACE**

Ja -1Kit x 1000mm		1000 x 12 x 42 mm	222899	30
-------------------	--	-------------------	--------	----

# Arca - Recessed

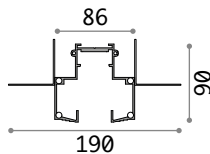
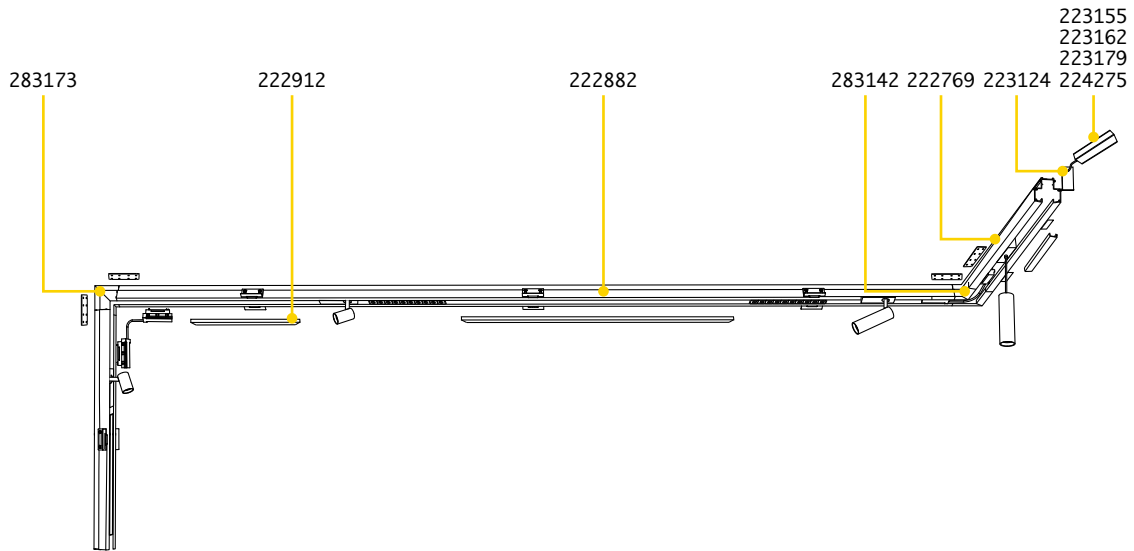

**TRACK** Inkl. Kit zur Montage des Profils + Endkappen  
Max. Länge zu jedem Stromanschlusspunkt: 25 Meter

Länge	Gewicht	Volumen	Ausführ.	Art-Nr.	€
1000 mm	2,90 Kg	0,0269 m <sup>3</sup>	Schwarz	222769	187
3000 mm	8,70 Kg	0,0617 m <sup>3</sup>	Schwarz	222882	490

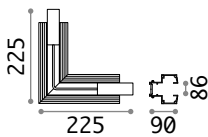

**BLINDED CORNER RIGHT-LEFT** Optionals

Gewicht	Volumen	Ausführ.	Art-Nr.	€
1,12 Kg	0,0090 m <sup>3</sup>	Schwarz	283142	150

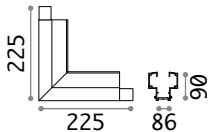

**BLINDED CORNER VERTICAL-HORIZONTAL** Optionals

Gewicht	Volumen	Ausführ.	Art-Nr.	€
1,12 Kg	0,0090 m <sup>3</sup>	Schwarz	283173	150



**LINEAR CONNECTOR**

Erforderlich	Kabellänge	Maß (LxH xB)	Art-Nr.	€
Ja -1Kit x Verbindungselement		100 x 18 x 38 mm	254944	25

**ELECTRIFIED END CAP**

Ja -1Kit x Stromanschlussp. max 210W	380 mm	86 x 80 x 42 mm	223124	23
--------------------------------------	--------	-----------------	--------	----



## Arca – Drivers and cover

### DRIVER MEANWELL ON/OFF Erforderlich



Leistung	Output	Klasse	Maß (LxH xB)	Art-Nr.	€
60 W	48 Vdc	⊕	171x37x62 mm	223155	140
90 W	48 Vdc	⊕	220x37x68 mm	223162	185
150 W	48 Vdc	⊕	228x37x68 mm	223179	205
240 W	48 Vdc	⊕	244x39x68 mm	224275	230

### DRIVER BOX Optionals



Material	Maß (LxH xB)	Farbe	Art-Nr.	€
Metal	255x55x75 mm	Weiß	302379	25 <small>new</small>
		Schwarz	302362	25 <small>new</small>
	330x60x80 mm	Weiß	302355	30 <small>new</small>
		Schwarz	302348	30 <small>new</small>

### BLINDED COVER Optionals



Material	Länge	Farbe	Art-Nr.	€
PC	990 mm	Schwarz	222912	8

# Ego <sup>new</sup>

Linearsystem aus mittels Extrusionsverfahren hergestelltem Aluminiumprofil und magnetischen Beleuchtungselementen mit mechanischer Sicherheitssperrvorrichtung. Das System ist in den folgenden Farben erhältlich: schwarz, weiß oder Messing satiniert für die Decken, Hänge- oder Einbaumontage erhältlich. Der Profilschnitt ist 26mm breit und 27mm oder 52mm hoch; in zwei Längen erhältlich: 1000mm und 2000mm. Möglichkeit mit verschiedenen Quellmodulen zu montieren; die Komponenten sind reversibel und bei Bedarf modifizierbar: die Module TRACK SINGLE, DOUBLE und FLAT SINGLE für eine Spot-Beleuchtung; die Module ACCENT mit Blendschutzkontrolle (UGR <19); das Module PENDANT TUBE für eine Objektbeleuchtung und die Module WIDE für eine gleichmäßig verteilende Beleuchtung. Integrierte LED mit Farbtemperatur von 3000 K und CRI 90. Betrieb, IP20 Schutz, Isolationsklasse III, 48 V Anschluss, Lebensdauer LED 50.000 h L70B50, auch 1-10V und DALI dimmbar erhältlich. Ideal zur Beleuchtung von kleinen und großen Räumen, in denen hohe Flexibilität und Farbwiedergabe erforderlich sind, wie zum Beispiel MUSEEN, GEWERBE-, VERKAUFS- oder WOHNFLÄCHEN.

**PRO** Hightech-Produkt mit hochwertigen Materialien, gedacht für einen professionellen Einsatz.

**UGR** Artikel mit UGR-Wert <19 (Accent, Pendant).

Lichtquelle	LED COB /SMD
Transformator	No
inklusive	
Verfügbare	On/Off
Transformatore	
Kontrolle	1-10V/DALI
MacAdam	SDCM 3
CCT	3000K
CRI	≥90
UGR	<19 (Accent, Pendant)
LED Lebensdauer	50.000h
Schutzklasse	III
IP	20
Material	Aluminium
Garantie	5 Jahre



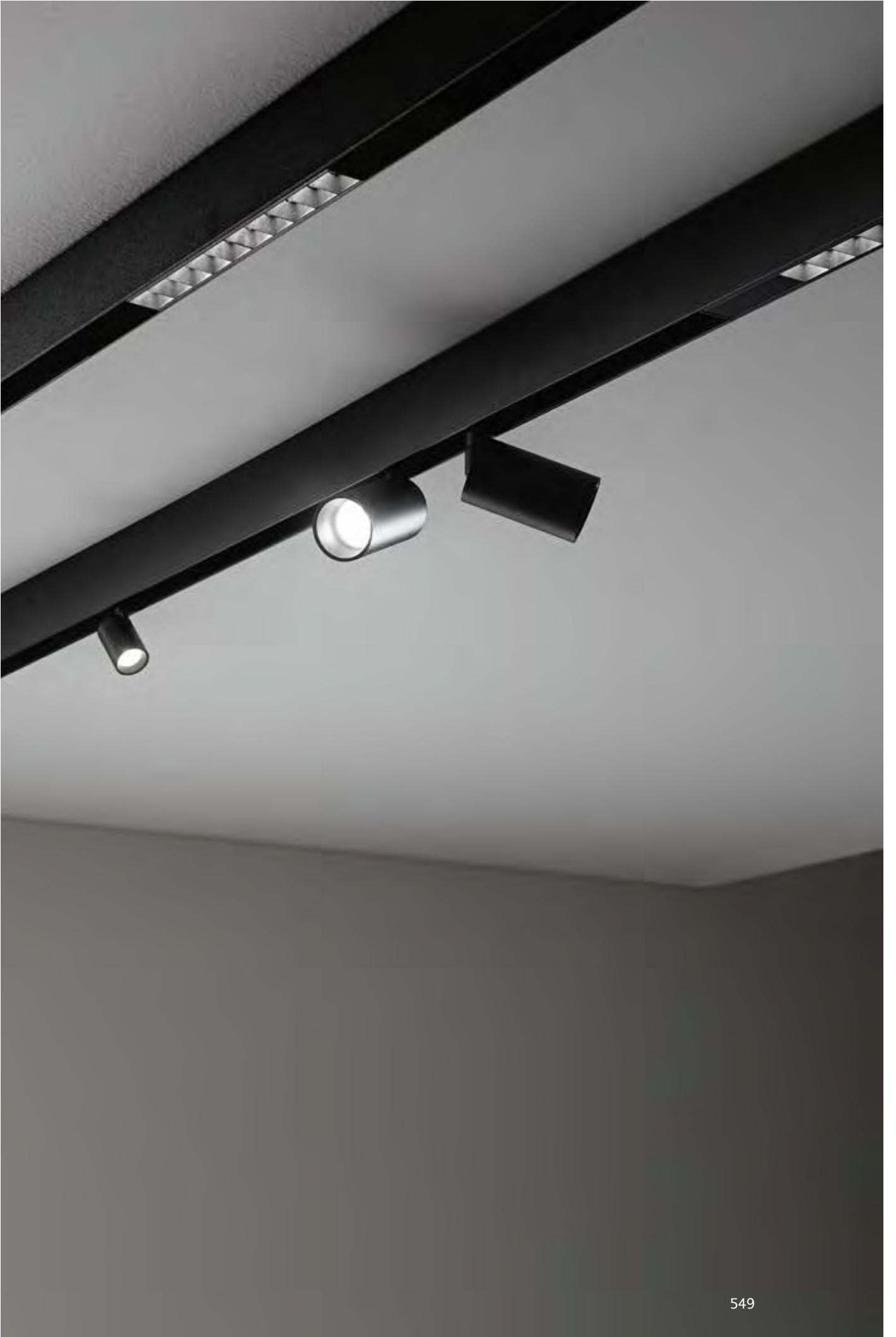

# Ego TrackSingle

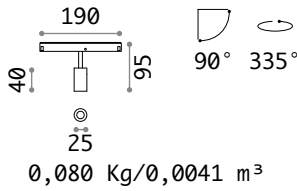

## LEDSMD OSRAM

Leistung	Beam	Lumen	CCT	Kontrolle	Ausführ.	Art.-Nr.	€
3 W	30°	190 lm	3000 K	On-Off	Weiß	282978	85
					Schwarz	257617	85
					Messing	282039	85
				1-10V	Weiß	303673	120 new
					Schwarz	303666	120 new
					DALI	Weiß	286402
					Schwarz	286396	140

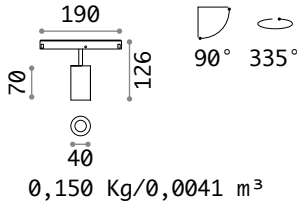

## LED COB CITIZEN

Leistung	Beam	Lumen	CCT	Kontrolle	Ausführ.	Art.-Nr.	€
8 W	30°	730 lm	3000 K	On-Off	Weiß	282985	107
					Schwarz	257631	107
					Messing	282046	107
				1-10V	Weiß	303697	130 new
					Schwarz	303680	130 new
					DALI	Weiß	286426
					Schwarz	286419	160

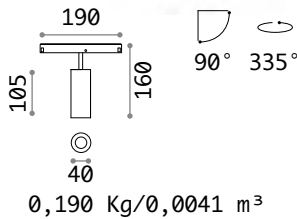

## LED COB CITIZEN

Leistung	Beam	Lumen	CCT	Kontrolle	Ausführ.	Art.-Nr.	€
12 W	30°	1000 lm	3000 K	On-Off	Weiß	282992	115
					Schwarz	257655	115
					Messing	282053	115
				1-10V	Weiß	303710	135 new
					Schwarz	303703	135 new
					DALI	Weiß	286440
					Schwarz	286433	165



## FILTER HONEYCOMB

Modell	Erforderlich	Art.-Nr.	€
Ego 3W	Nein	260853	5
Ego 8W	Nein	260860	5
Ego 12W	Nein	260860	5



Light beam: ACCENT

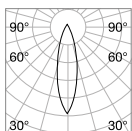

m	lx	øm
1	537	0,46
2	134	0,92
3	60	1,40
4	34	1,80
5	21	2,30

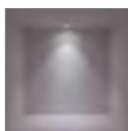

CRI≥90 3W 30° 230lm 3000K

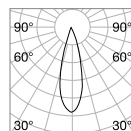

m	lx	øm
1	2393	0,49
2	598	0,98
3	266	1,50
4	150	2,00
5	96	2,50



CRI≥90 8W 30° 750lm 3000K

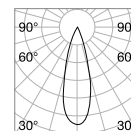

m	lx	øm
1	2877	0,51
2	719	1,00
3	320	1,50
4	180	2,10
5	115	2,60

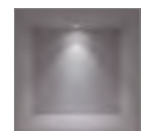

CRI≥90 12W 30° 1000lm 3000K

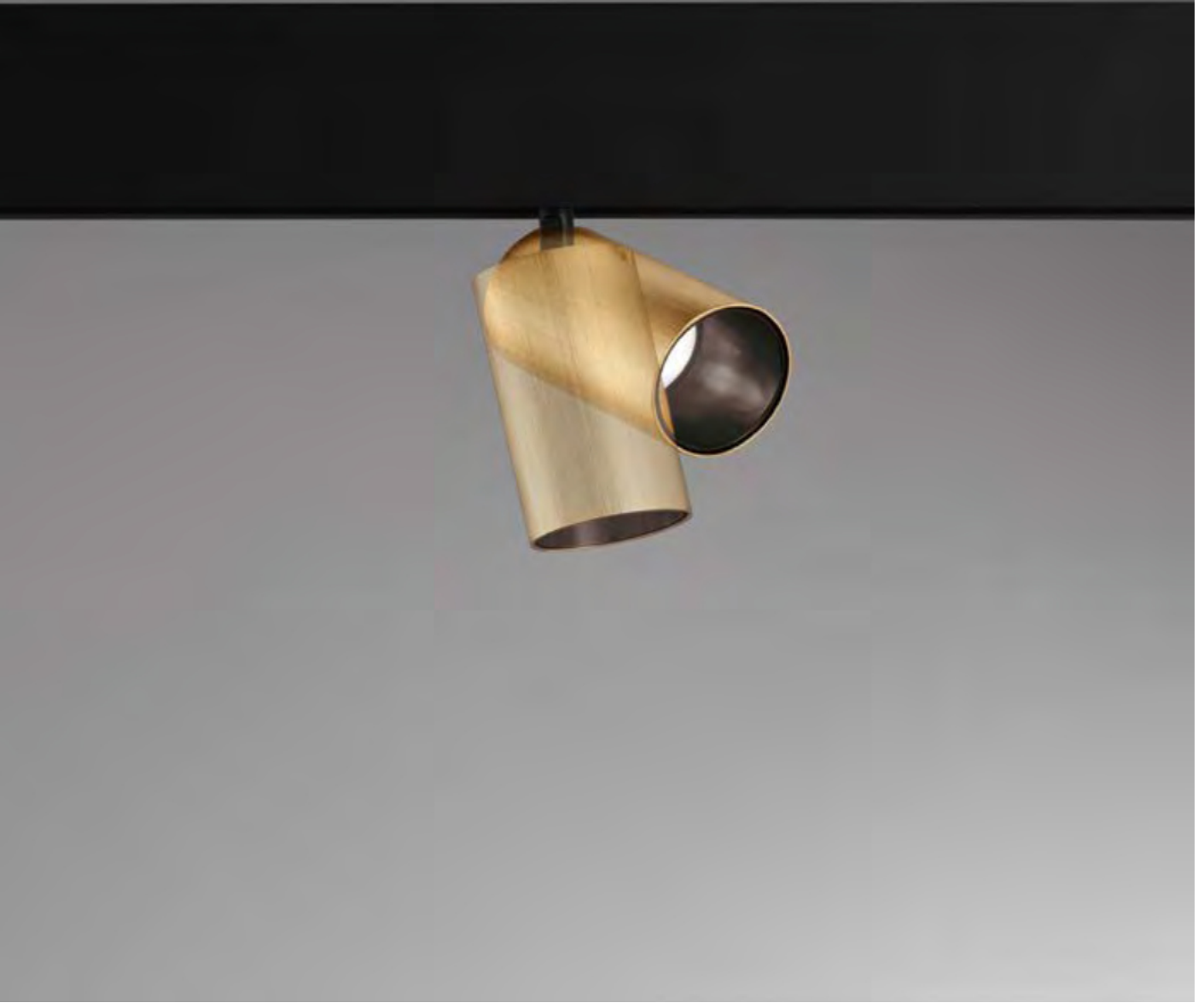

# Ego TrackSingle

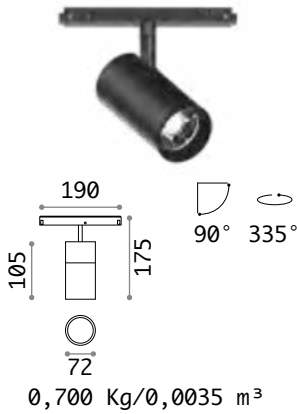

## LED COB CITIZEN

Leistung	Beam	Lumen	CCT	Kontrolle	Ausführ.	Art.-Nr.	€
19W	35°	2200 lm	3000 K	On-Off	Weiß	307558	175 <i>new</i>
					Schwarz	305608	175 <i>new</i>
				1-10V	Weiß	307527	195 <i>new</i>
					Schwarz	307510	195 <i>new</i>
				DALI	Weiß	307541	230 <i>new</i>
					Schwarz	307534	230 <i>new</i>

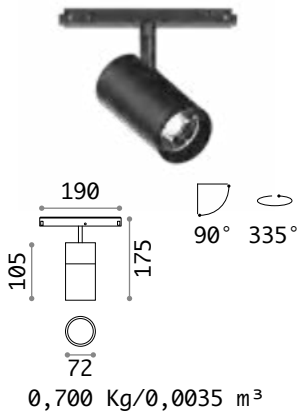

## LED COB CITIZEN

Leistung	Beam	Lumen	CCT	Kontrolle	Ausführ.	Art.-Nr.	€
26 W	35°	2950 lm	3000 K	On-Off	Weiß	307602	180 <i>new</i>
					Schwarz	305615	180 <i>new</i>
				1-10V	Weiß	307572	200 <i>new</i>
					Schwarz	307565	200 <i>new</i>
				DALI	Weiß	307596	235 <i>new</i>
					Schwarz	307589	235 <i>new</i>



Light beam: ACCENT

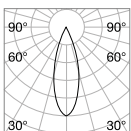

m	lx	øm
1	4476	0,57
2	1119	1,10
3	497	1,70
4	280	2,30
5	179	2,90

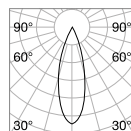

m	lx	øm
1	6816	0,56
2	1704	1,10
3	757	1,70
4	426	2,20
5	273	2,80



CRI≥90 19W 35° 2200lm 3000K

CRI≥90 26W 35° 2950lm 3000K





# Ego Track Double

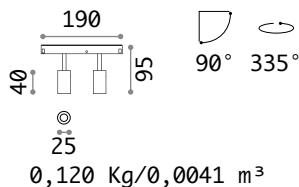
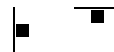

## LEDSMD OSRAM

Leistung	Beam	Lumen	CCT	Kontrolle	Ausführ.	Art.-Nr.	€
5 W	30°	380 lm	3000 K	On-Off	Weiß	282947	120
					Schwarz	257624	120
					Messing	282008	120
					1-10V Weiß	303611	145 new
					Schwarz	303604	145 new
					DALI Weiß	286341	170
				DALI	Schwarz	286334	170

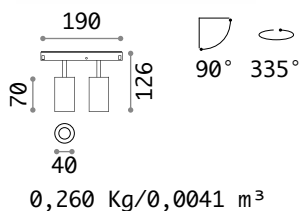

## LED COB CITIZEN

Leistung	Beam	Lumen	CCT	Kontrolle	Ausführ.	Art.-Nr.	€
16W	30°	1450 lm	3000 K	On-Off	Weiß	282954	160
					Schwarz	257648	160
					Messing	282015	160
					1-10V Weiß	303635	190 new
					Schwarz	303628	190 new
					DALI Weiß	286365	210
				DALI	Schwarz	286358	210

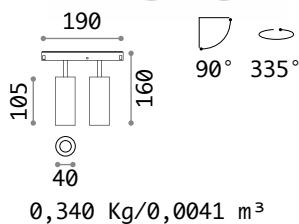

## LED COB CITIZEN

Leistung	Beam	Lumen	CCT	Kontrolle	Ausführ.	Art.-Nr.	€
24 W	30°	2000 lm	3000 K	On-Off	Weiß	282961	170
					Schwarz	257662	170
					Messing	282022	170
					1-10V Weiß	303659	195 new
					Schwarz	303642	195 new
					DALI Weiß	286389	220
				DALI	Schwarz	286372	220



## FILTER HONEYCOMB

Modell	Erforderlich	Art.-Nr.	€
Ego 5W	Nein	260853	5
Ego 16W	Nein	260860	5
Ego 24W	Nein	260860	5



Light beam: ACCENT

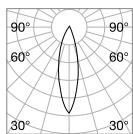

m	lx	Øm
1	508	0,46
2	127	0,92
3	56	1,40
4	32	2,80
5	20	2,30

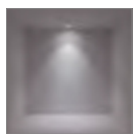

CRI≥90 5W 30° 450lm 3000K

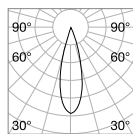

m	lx	Øm
1	2451	0,49
2	613	1,98
3	272	1,50
4	153	2,00
5	98	2,50



CRI≥90 16W 30° 1500lm 3000K

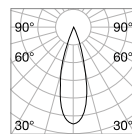

m	lx	Øm
1	3051	0,51
2	763	1,00
3	339	1,50
4	191	2,10
5	122	2,60



CRI≥90 24W 30° 2200lm 3000K



# Ego Track Flat

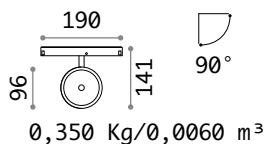
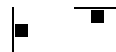

## LED COB CITIZEN

Leistung	Beam	Lumen	CCT	Kontrolle	Ausführ.	Art.-Nr.	€
9W	36°	1100lm	3000K	On-Off	Weiß	300504	125 <i>new</i>
					Schwarz	290614	125 <i>new</i>
					Messing	300511	125 <i>new</i>
				1-10V	Weiß	303741	140 <i>new</i>
					Schwarz	303727	140 <i>new</i>
					Messing	303734	140 <i>new</i>
				DALI	Weiß	300535	175 <i>new</i>
					Schwarz	300528	175 <i>new</i>
					Messing	300542	175 <i>new</i>



Light beam: ACCENT

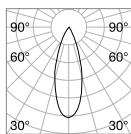

m	lx	øm
1	2242	0,60
2	560	1,20
3	249	1,80
4	140	2,40
5	90	3,00



CRI≥90 9W 36° 1100lm 3000K

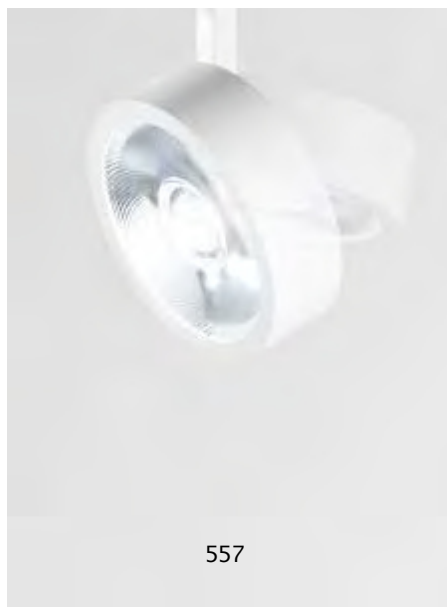
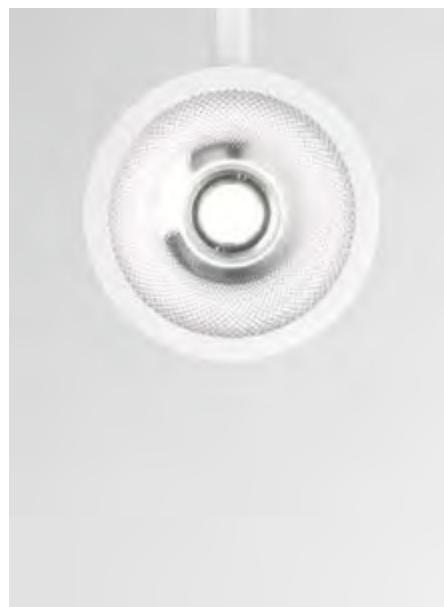

# Ego Accent

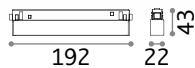

0,140 Kg/0,0013 m<sup>3</sup>

## LEDSMD OSRAM UGR <19

Leistung	Beam	Lumen	CCT	Kontrolle	Ausführ.	Art.-Nr.	€
7W	35°	700 lm	3000 K	On-Off	Weiß	282633	115
					Schwarz	257792	115
				1-10V	Weiß	303505	155 <i>new</i>
					Schwarz	303499	155 <i>new</i>
				DALI	Weiß	286068	170
					Schwarz	286051	170

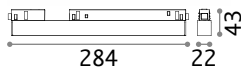

0,210 Kg/0,0019 m<sup>3</sup>

## LEDSMD OSRAM UGR <19

Leistung	Beam	Lumen	CCT	Kontrolle	Ausführ.	Art.-Nr.	€
13W	35°	1300 lm	3000 K	On-Off	Weiß	282640	165
					Schwarz	257686	165
				1-10V	Weiß	303529	190 <i>new</i>
					Schwarz	303512	190 <i>new</i>
				DALI	Weiß	286082	230
					Schwarz	286075	230

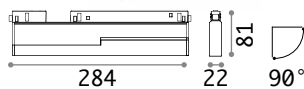

0,470 Kg/0,0031 m<sup>3</sup>

## LEDSMD OSRAM UGR <19

Leistung	Beam	Lumen	CCT	Kontrolle	Ausführ.	Art.-Nr.	€
13W	35°	1300 lm	3000 K	On-Off	Weiß	282718	200
					Schwarz	257846	200
				1-10V	Weiß	303543	225 <i>new</i>
					Schwarz	303536	225 <i>new</i>
				DALI	Weiß	286105	250
					Schwarz	286099	250



Light beam: ACCENT

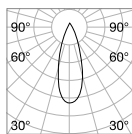

m	lx	øm
1	3121	0,61
2	780	1,20
3	347	1,80
4	195	2,40
5	125	3,00

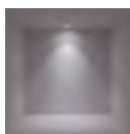

CRI≥90 13W 35° 1500lm 3000K



EGO FLEXIBLE ACCENT

Ego Accent 192 mm



Ego Accent 284 mm



# Ego Wide

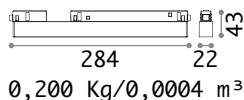

0,200 Kg/0,0004 m<sup>3</sup>

## LEDSMD SAMSUNG

Leistung	Beam	Lumen	CCT	Kontrolle	Ausführ.	Art-Nr.	€
7W	110°	820 lm	3000 K	On-Off	Weiß	283029	85
					Schwarz	257709	85
1-10V	110°	820 lm	3000 K	1-10V	Weiß	303796	130 <small>new</small>
					Schwarz	303789	130 <small>new</small>
DALI	110°	820 lm	3000 K	DALI	Weiß	286501	145
					Schwarz	286495	145

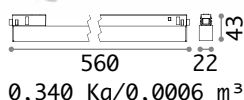

0,340 Kg/0,0006 m<sup>3</sup>

## LEDSMD SAMSUNG

Leistung	Beam	Lumen	CCT	Kontrolle	Ausführ.	Art-Nr.	€
13W	110°	1650 lm	3000 K	On-Off	Weiß	283036	118
					Schwarz	257716	118
1-10V	110°	1650 lm	3000 K	1-10V	Weiß	303819	165 <small>new</small>
					Schwarz	303802	165 <small>new</small>
DALI	110°	1650 lm	3000 K	DALI	Weiß	286525	170
					Schwarz	286518	170

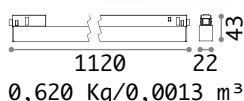

0,620 Kg/0,0013 m<sup>3</sup>

## LEDSMD SAMSUNG

Leistung	Beam	Lumen	CCT	Kontrolle	Ausführ.	Art-Nr.	€
26 W	110°	3300 lm	3000 K	On-Off	Weiß	283043	170
					Schwarz	257730	170
1-10V	110°	3300 lm	3000 K	1-10V	Weiß	303833	200 <small>new</small>
					Schwarz	303826	200 <small>new</small>
DALI	110°	3300 lm	3000 K	DALI	Weiß	286549	215
					Schwarz	286532	215

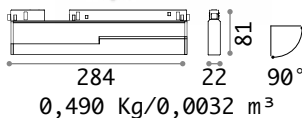

0,490 Kg/0,0032 m<sup>3</sup>

## LEDSMD SAMSUNG

Leistung	Beam	Lumen	CCT	Kontrolle	Ausführ.	Art-Nr.	€
7W	110°	820 lm	3000 K	On-Off	Weiß	282725	135
					Schwarz	257839	135
1-10V	110°	820 lm	3000 K	1-10V	Weiß	303567	165 <small>new</small>
					Schwarz	303550	165 <small>new</small>
DALI	110°	820 lm	3000 K	DALI	Weiß	286129	185
					Schwarz	286112	185



Light beam: WIDE

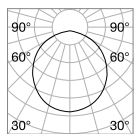

m	lx	cm
1	619	2,50
2	155	4,90
3	69	7,40
4	39	9,80
5	25	12,00

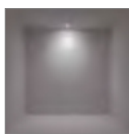

CRI≥90 26W 110° 2400lm 3000K





EGO FLEXIBLE WIDE

Ego Wide 284 mm



Ego Wide 560 mm



Ego Wide 1120 mm



# Ego Pendant

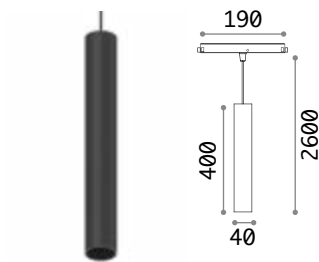

0,540 Kg/0,0038 m<sup>3</sup>

LED COB CITIZEN UGR <19

Leistung	Beam	Lumen	CCT	Kontrolle	Ausführ.	Art.-Nr.	€
12W	30°	1000 lm	3000 K	On-Off	Weiß	282879	165
					Schwarz	257747	165
					Messing	283852	165 new
				1-10V	Weiß	303598	200 new
					Schwarz	303574	200 new
					Messing	303581	200 new
				DALI	Weiß	286327	215
					Schwarz	286310	215
					Messing	300498	215 new



Light beam: ACCENT

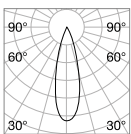

m	lx	øm
1	2877	0,51
2	719	1,00
3	320	1,50
4	180	2,10
5	115	2,60



CRI≥90 12W 30° 1000lm 3000K



# Ego – Suspension Low

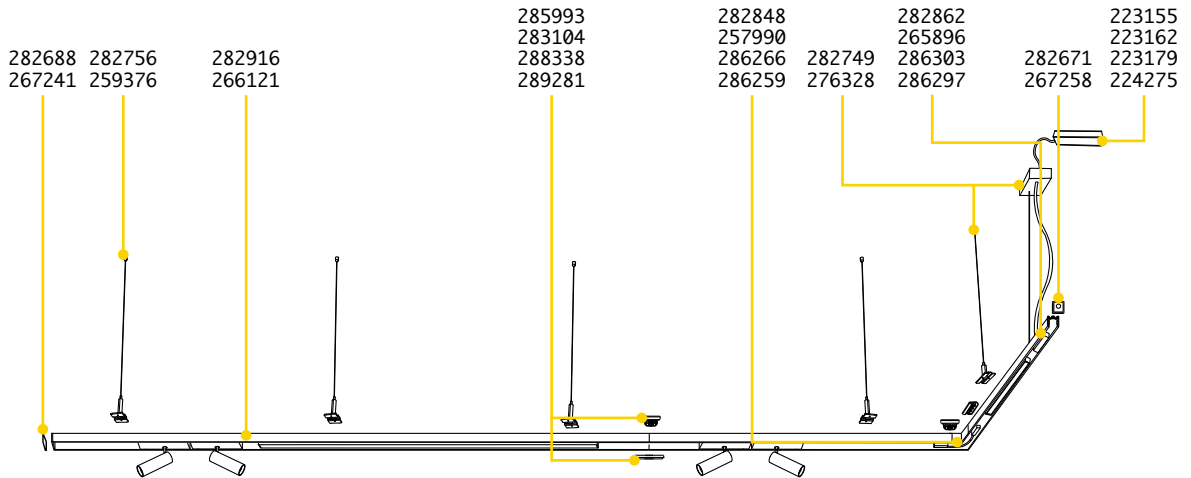

**TRACK LOW** Max. Länge zu jedem Stromanschlusspunkt: 25 Meter

Länge	Gewicht	Volumen	Ausführ.	Art.-Nr.	€
1000 mm	0,68 Kg	0,0013 m <sup>3</sup>	Weiß	282909	57
			Schwarz	257877	57
2000 mm	1,36Kg	0,0026 m <sup>3</sup>	Weiß	282916	115
			Schwarz	266121	115

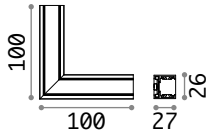

**CONNECTOR HORIZONTAL LOW** Optionals

Gewicht	Volumen	Kontrolle	Ausführ.	Art.-Nr.	€
0,07Kg	0,0015 m <sup>3</sup>	On-Off	Weiß	282848	75
			Schwarz	257990	75
			1-10V/DAI Weiß	286266	85
			Schwarz	286259	85



**END CAP NO HOLE**

**END CAP WITH HOLE**

**SUSPENSION KIT**

**KITSINGLE CABLE**

Erforderlich	Maß (LxH xB)	Ausführ.	Art.-Nr.	€
Ja	26 x 11x27 mm	Weiß	282688	5
		Schwarz	267241	5
Ja	26 x 11x27 mm	Weiß	282671	5
		Schwarz	267258	5
Ja -1Kit x Stromanschlussp. max 210W	2000 mm	Weiß	282749	46
		Schwarz	276328	46
Ja -1kit x 900 mm	2000 mm	Weiß	282756	15
		Schwarz	259376	15

# Ego - Suspension High

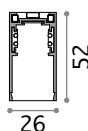
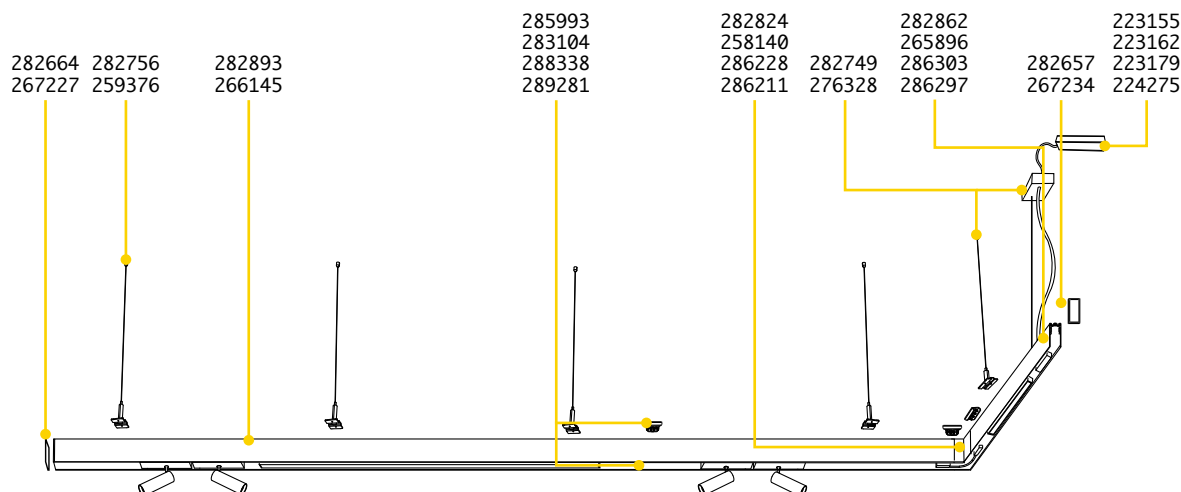

**TRACK HIGH** Max. Länge zu jedem Stromanschlusspunkt: 25 Meter

Länge	Gewicht	Volumen	Ausführ.	Art-Nr.	€
1000 mm	0,80Kg	0,0023 m <sup>3</sup>	Weiß	282886	62
			Schwarz	258027	62
2000 mm	1,60Kg	0,0046 m <sup>3</sup>	Weiß	282893	125
			Schwarz	266145	125

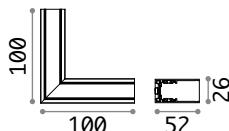

**CONNECTOR HORIZONTALHIGH** Optionals

Gewicht	Volumen	Kontrolle	Ausführ.	Art-Nr.	€
0,10Kg	0,0015 m <sup>3</sup>	On-Off  1-10V/DAU	Weiß	282824	75
			Schwarz	258140	75
			Weiß	286228	85
			Schwarz	286211	85



**ENDCAP NO HOLE**

**ENDCAP WITH HOLE**

**SUSPENSION KIT**

**KIT SINGLE CABLE**

Erforderlich	Maß (LxHxB)	Ausführ.	Art-Nr.	€
Ja	26 x 11x52 mm	Weiß	282664	5
		Schwarz	267227	5
Ja	26 x 11x52 mm	Weiß	282657	5
		Schwarz	267234	5
Ja -1Kit x Stromanschlussp. max 210W	2000 mm	Weiß	282749	46
		Schwarz	276328	46
Ja -1kit x 900 mm	2000 mm	Weiß	282756	15
		Schwarz	259376	15

# Ego – Surface Low

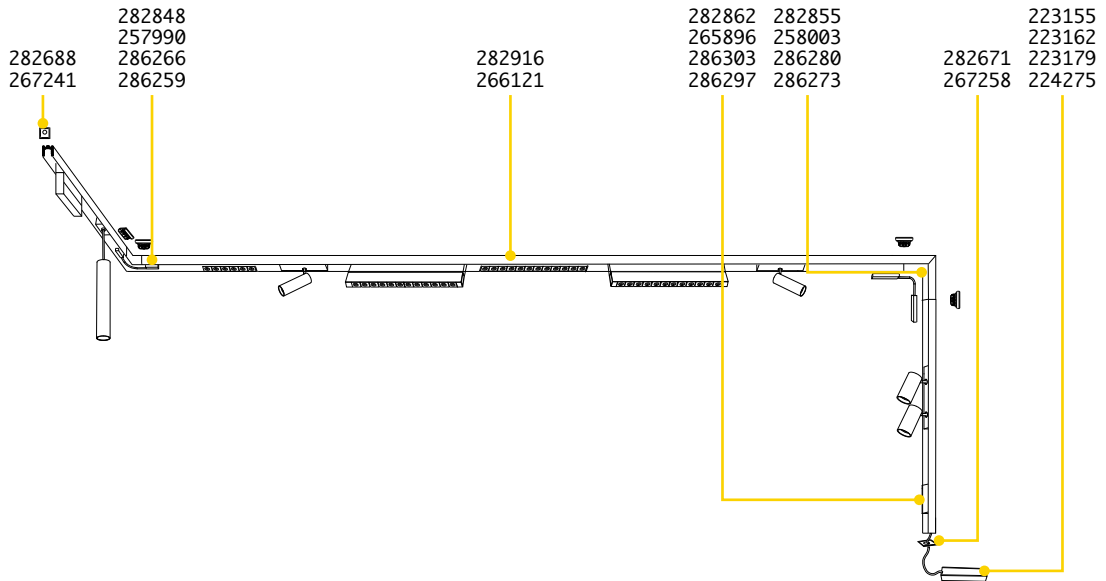

**TRACK LOW** Montagekit nicht erforderlich, Deckenmontage direkt  
Max. Länge zu jedem Stromanschlusspunkt: 25 Meter



Länge	Gewicht	Volumen	Ausführ.	Art.-Nr.	€
1000 mm	0,68 Kg	0,0013 m <sup>3</sup>	Weiß	282909	57
			Schwarz	257877	57
2000 mm	1,36Kg	0,0026 m <sup>3</sup>	Weiß	282916	115
			Schwarz	266121	115

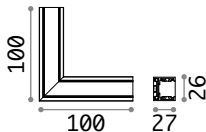

**CONNECTOR HORIZONTAL LOW** Optionals

Gewicht	Volumen	Kontrolle	Ausführ.	Art.-Nr.	€
0,07Kg	0,0015 m <sup>3</sup>	On-Off	Weiß	282848	75
			Schwarz	257990	75
		DALI	Weiß	286266	85
			Schwarz	286259	85

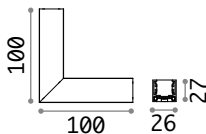

**CONNECTOR VERTICAL LOW** Optionals

Gewicht	Volumen	Kontrolle	Ausführ.	Art.-Nr.	€
0,07Kg	0,0015 m <sup>3</sup>	On-Off	Weiß	282855	75
			Schwarz	258003	75
		1-10V/DALI	Weiß	286280	85
			Schwarz	286273	85



**ENDCAP NO HOLE**



**ENDCAP WITH HOLE**

Erforderlich	Maß (LxH xB)	Ausführ.	Art.-Nr.	€
Ja	26 x 11x27 mm	Weiß	282688	5
		Schwarz	267241	5
Ja	26 x 11x27 mm	Weiß	282671	5
		Schwarz	267258	5

# Ego - Surface High

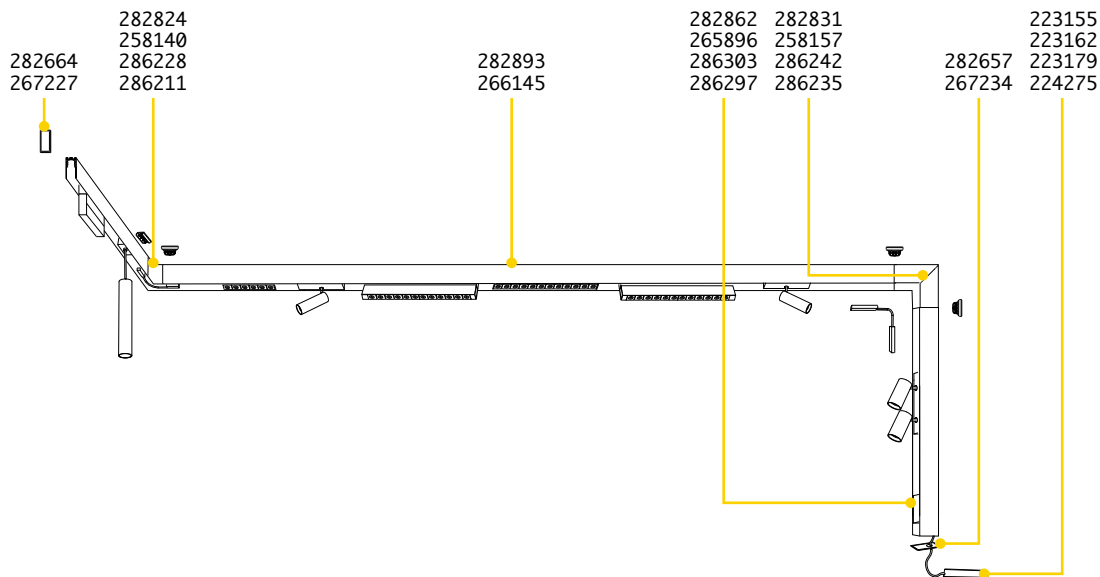

**TRACK HIGH** Montagekit nicht erforderlich, Deckenmontage direkt  
Max. Länge zu jedem Stromanschlusspunkt: 25 Meter

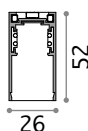

Länge	Gewicht	Volumen	Ausführ.	Art-Nr.	€
1000 mm	0,80 Kg	0,0023 m <sup>3</sup>	Weiß	282886	62
			Schwarz	258027	62
2000 mm	1,60Kg	0,0046 m <sup>3</sup>	Weiß	282893	125
			Schwarz	266145	125

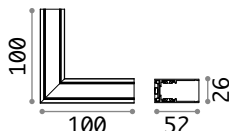

**CONNECTOR HORIZONTALHIGH** Optionals

Gewicht	Volumen	Kontrolle	Ausführ.	Art-Nr.	€
0,10Kg	0,0015 m <sup>3</sup>	On-Off	Weiß	282824	75
			Schwarz	258140	75
			Weiß	286228	85
			Schwarz	286211	85

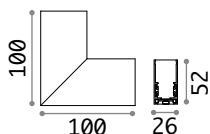

**CONNECTOR VERTICALHIGH** Optionals

Gewicht	Volumen	Kontrolle	Ausführ.	Art-Nr.	€
0,10Kg	0,0015 m <sup>3</sup>	On-Off	Weiß	282831	75
			Schwarz	258157	75
			Weiß	286242	85
			Schwarz	286235	85



**ENDCAP NO HOLE**



**ENDCAP WITH HOLE**

Erforderlich	Maß (LxH xB)	Ausführ.	Art-Nr.	€
Ja	26 x 11x52 mm	Weiß	282664	5
		Schwarz	267227	5
Ja	26 x 11x52 mm	Weiß	282657	5
		Schwarz	267234	5

# Ego – Recessed

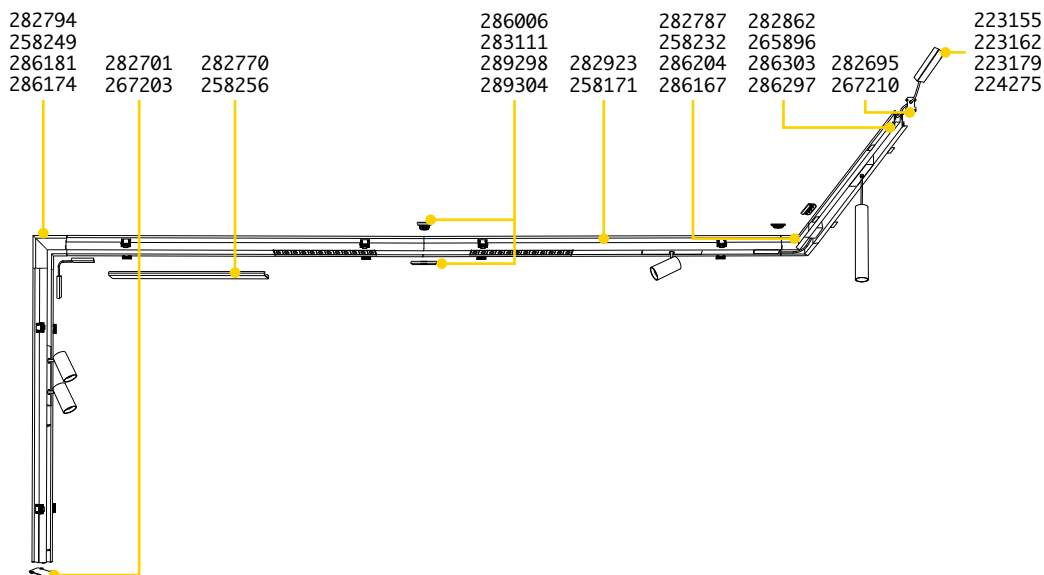

## TRACK Montagekit Profil inklusive Max. Länge zu jedem Stromanschlusspunkt: 25 Meter

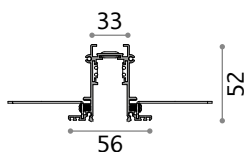

Länge	Gewicht	Volumen	Ausführ.	Art.-Nr.	€
1000 mm	1,13Kg	0,0039 m <sup>3</sup>	Weiß	282923	71
			Schwarz	258171	71
2000 mm	2,26Kg	0,0078 m <sup>3</sup>	Weiß	282930	150
			Schwarz	266183	150

## CONNECTOR HORIZONTAL Optionals

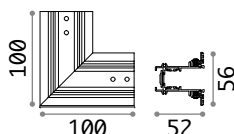

Gewicht	Volumen	Kontrolle	Ausführ.	Art.-Nr.	€	
0,13Kg	0,0015 m <sup>3</sup>	On-Off	Weiß	282787	75	
			Schwarz	258232	75	
			1-10V/DALI	Weiß	286204	95
			Schwarz	286167	95	

## CONNECTOR VERTICAL 90° Optionals

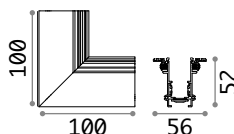

Gewicht	Volumen	Kontrolle	Ausführ.	Art.-Nr.	€	
0,10Kg	0,0015 m <sup>3</sup>	On-Off	Weiß	282794	75	
			Schwarz	258249	75	
			1-10V/DALI	Weiß	286181	95
			Schwarz	286174	95	

## CONNECTOR VERTICAL 270° Optionals

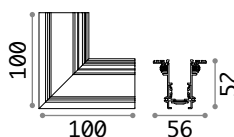

Gewicht	Volumen	Kontrolle	Ausführ.	Art.-Nr.	€	
0,14Kg	0,0015 m <sup>3</sup>	On-Off	Weiß	282800	75	
			Schwarz	259413	75	
			1-10V/DALI	Weiß	286150	95
			Schwarz	286198	95	



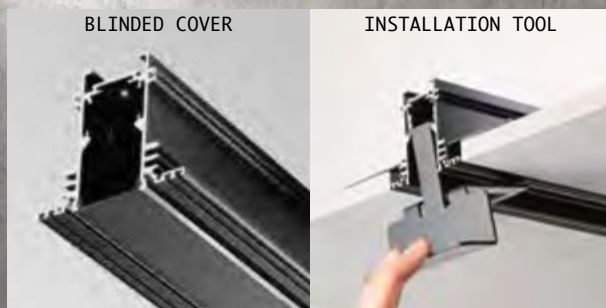

ENDCAP NO HOLE

ENDCAP WITH HOLE

BLINDED COVER

INSTALLATION TOOL

Erforderlich	Maß (LxH xB)	Ausführ.	Art-Nr.	€
Ja	36 x 4 x 52 mm	Weiß	282701	5
		Schwarz	267203	5
Ja	36 x 4 x 52 mm	Weiß	282695	5
		Schwarz	267210	5
Nein	1000 x 5 x 24 mm	Weiß	282770	15
		Schwarz	258256	15
Nein		Schwarz	292922	26 <small>new</small>

# Ego – Connectors and drivers

## SUSPENSION AND SURFACE LINEAR CONNECTOR

Erforderlich – 1Kit x lineares Verbindungselement

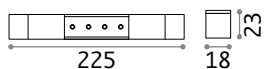

Gewicht	Volumen	Kontrolle	Ausführ.	Art.-Nr.	€
0,16Kg	0,0005 m <sup>3</sup>	On-Off	Weiß	285993	45
			Schwarz	283104	45
		1-10V/DAI	Weiß	288338	50
			Schwarz	289281	50

## RECESSED LINEAR CONNECTOR

Erforderlich – 1Kit x lineares Verbindungselement

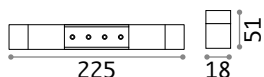

Gewicht	Volumen	Kontrolle	Ausführ.	Art.-Nr.	€
0,16Kg	0,0005 m <sup>3</sup>	On-Off	Weiß	286006	45
			Schwarz	283111	45
		1-10V/DAI	Weiß	289298	50
			Schwarz	289304	50

## MAIN CONNECTOR

Erforderlich – 1Kit x Stromanschlussp. max 210W

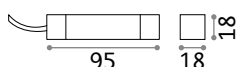

Kabellänge 2000 mm

Gewicht	Volumen	Kontrolle	Ausführ.	Art.-Nr.	€
0,12Kg	0,0005 m <sup>3</sup>	On-Off	Weiß	282862	36
			Schwarz	265896	36
		1-10V/DAI	Weiß	286303	43
			Schwarz	286297	43

## DRIVER MEANWELL

Erforderlich



Leistung	Output	Klasse	Maß (LxH xB)	Art.-Nr.	€
60 W	48 Vdc	⊕	171x37x62 mm	223155	140
90 W	48 Vdc	⊕	220x37x68 mm	223162	185
150 W	48 Vdc	⊕	228x37x68 mm	223179	205
240 W	48 Vdc	⊕	244x39x68 mm	224275	230

## MAGNETIC DRIVER

Erforderlich – Kabellänge 2000 mm



Leistung	Output	Klasse	Maß (LxH xB)	Art.-Nr.	€
100 W	48 Vdc	⊖	297x20x16 mm	296302	80 <small>new</small>

## DRIVER BOX

Optionals



Material	Maß (LxH xB)	Farbe	Art.-Nr.	€
Metal	255x55x75 mm	Weiß	302379	25 <small>new</small>
		Schwarz	302362	25 <small>new</small>
	330x60x80 mm	Weiß	302355	30 <small>new</small>
		Schwarz	302348	30 <small>new</small>



PROFILE LOW



PROFILE HIGH



# Linus



Linearleuchte aus Aluminium mit direktem und indirektem Licht. Die Leuchte ist modular, kann als Einzelleuchte oder kontinuierliche Lichtlinie gestaltet werden. LED integriert; Binning initial  $\leq 3$ -Step MacAdam; CRI  $\geq 80$ ; Schutzart IP20, Schutzklasse I. Dimmbarer Treiber 1-10V integriert.

Lichtquelle	LED SMD	CRI	$\geq 80$
Leistung	32W	LED Lebensdauer	50.000 h
Transformator	1-10V	Schutzklasse	I
inklusive		IP	20
Verfügbare	No	Material	Aluminium
Transformatore		Garantie	5 Jahre
MacAdam	SDCM 3		
CCT	3000 K / 4000 K		

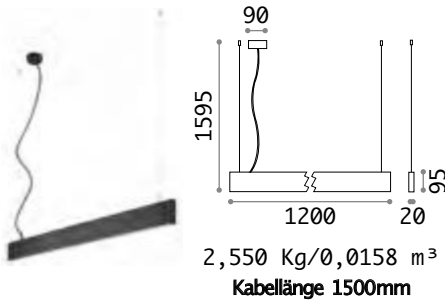

## LED SMD Up-light inklusive - 1-10V Transfor. inklusive

Leistung	Beam	Lumen	CCT	Ausführ.	Art-Nr.	€
32 W	104°	3450 lm	3000 K	Weiß	241968	220
				Schwarz	241975	220
		3600 lm	4000 K	Weiß	268231	220
				Schwarz	268217	220

## UP-LIGHT INFO

Leistung	Beam	Lumen	CCT
32 W	104°	3450 lm	3000 K
		3600 lm	4000 K

## CORNER Optionals

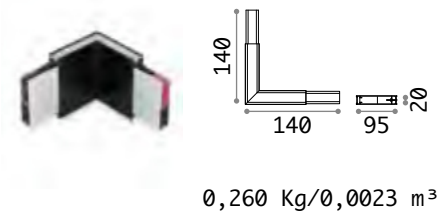

Leistung	Beam	Lumen	CCT	Ausführ.	Art-Nr.	€
4 W	104°	430 lm	3000 K	Weiß	241999	46
				Schwarz	242002	46
		450 lm	4000 K	Weiß	268149	46
				Schwarz	268118	46



## STRUCTURE CONNECTOR

Erforderlich	Art-Nr.	€
Ja - 1 Kit x Verbindungs.	241982	6



Light beam: BI-EMISSION WIDE

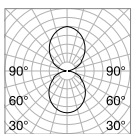

m	lx	Øm
1	572	2,56
2	143	5,12
3	64	7,68
4	36	10,24
5	23	12,80



CRI  $\geq 80$  32W 104° 3450lm 3000K





241968

268231

# Fluo

Linearsystem von Leuchten aus extrudiertem Aluminium, 50 mm Breite und 80 mm Höhe. Module in zwei Längen lieferbar: 1200mm und 1800mm, nach gewünschter Anordnung kombinierbar. In drei verschiedenen Konfigurationen verfügbar: WIDE-Modul verteilend, BI-EMISSION-Modul mit Teil für indirektes Licht und ACCENT-Modul mit Blendschutz (UGR <13); LED integriert, lieferbar in den Lichtfarben 3000 K oder 4000 K; Binning initial  $\leq 3$ -Step MacAdam; Schutzart IP20; Schutzklasse I; Lebensdauer LED 50.000h L70B50. Lieferbar in den Farben Aluminium eloxiert, Weiß, Schwarz; geeignet für die Decke, Hängemontage oder randlosen Einbau in Gipskartondecken als Einzelleuchte oder kontinuierliche Lichtlinie. Driver inklusive, im Leuchtkörper enthalten, dimmbar in der Varianten 1-10V, DALI und Push. Geeignet für Räume, wo nach professioneller Beleuchtung mit minimalistischem Design gefragt wird, wie zum Beispiel BÜROS und GEWERBEFLÄCHEN.

**PRO** Hightech-Produkt mit hochwertigen Materialien, gedacht für einen professionellen Einsatz.

**UGR** Artikel mit UGR-Wert <13 (Accent).

Lichtquelle	LED COB /SMD
Transformator	On/Off
inklusive	
Verfügbare	1-10V/DALI
Transformatore	
MacAdam	SDCM 3
Abstrahlwinkel	Accent/Wide /Bi-Emission
CCT	3000 K /4000 K
CRI	$\geq 83$
UGR	<13 (Accent)
LED Lebensdauer	50.000 h
Schutzklasse	I
IP	20
Material	Aluminium
Garantie	5 Jahre





# Fluo Accent

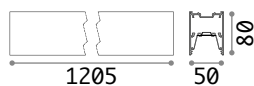

2,760 Kg/0,0183 m<sup>3</sup>  
Kabellänge 1800mm

**LED SMD OSRAM TRIDONIC ON/OFF Transformatorinklusive –UGR <13**

Leistung	Beam	Lumen	CCT	Ausführ.	Art.-Nr.	€
30 W	30°	2750 lm	3000 K	Aluminiu.	192635	360
				Weiß	192611	360
				Schwarz	192581	360
		2900 lm	4000 K	Aluminiu.	192574	360
				Weiß	192543	360
				Schwarz	192529	360

**DIMMABLE DRIVER\*** Optionals

	Leistung	Output	Maß (LxH xB)	Art.-Nr.	€
1-10V	39 W	700 mA	280 x 21x 30 mm	216416	128
DALI/Push	38 W	700 mA	280 x 21x 30 mm	216270	145



3,860 Kg/0,0269 m<sup>3</sup>  
Kabellänge 1800mm

**LED SMD OSRAM TRIDONIC ON/OFF Transformatorinklusive –UGR <13**

Leistung	Beam	Lumen	CCT	Ausführ.	Art.-Nr.	€
30 W	30°	2750 lm	3000 K	Aluminiu.	192512	430
				Weiß	192499	430
				Schwarz	192475	430
		2900 lm	4000 K	Aluminiu.	192451	430
				Weiß	192444	430
				Schwarz	192420	430

**DIMMABLE DRIVER\*** Optionals

	Leistung	Output	Maß (LxH xB)	Art.-Nr.	€
1-10V	39 W	700 mA	280 x 21x 30 mm	216416	128
DALI/Push	38 W	700 mA	280 x 21x 30 mm	216270	145

**MOUNTING KIT** Erforderlich –Seite 583



Light beam: ACCENT

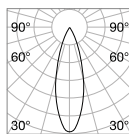

m	lx	øm
1	8264	0,48
2	2066	0,96
3	918	1,45
4	516	1,93
5	330	2,42

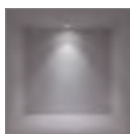

CRI≥83 30W 30° 3300lm 4000K

\* Dimmbare Treiber müssen mit dem Artikel mitbestellt werden und werden bei dem Produkt anstelle der on-off Treiber eingebaut. Kontinuierliche Lichtlinie ist nur für die Varianten on-off verfügbar.





Fluo Accent 1200

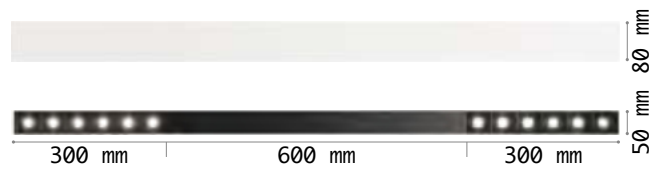

Fluo Accent 1800

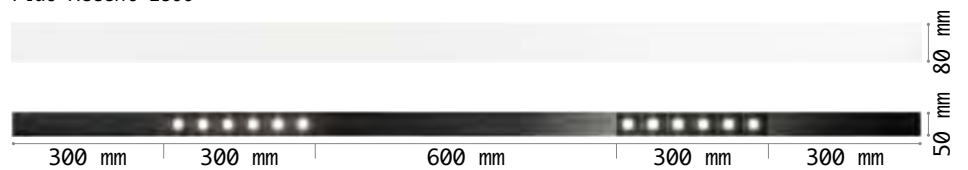

Die einzelne Endkappe ist 2,5 mmstark.

# Fluo Wide

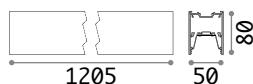

2,890 Kg/Ø,0183 m<sup>3</sup>  
Kabellänge 2150mm

## LED SMD SAMSUNG TRIDONIC ON/OFF Transformatorinklusive

Leistung	Beam	Lumen	CCT	Ausführ.	Art-Nr.	€
27W	105°	3750 lm	3000 K	Aluminiu.	191447	330
				Weiß	192437	330
				Schwarz	191997	330
		4050 lm	4000 K	Aluminiu.	192468	330
				Weiß	192482	330
				Schwarz	192505	330

## DIMMABLE DRIVER\* Optionals

	Leistung	Output	Maß (LxH xB)	Art-Nr.	€
1-10V	28 W	500 mA	280 x 21x 30 mm	216423	128
DALI/Push	27W	500 mA	280 x 21x 30 mm	216287	145



4,420 Kg/Ø,0269 m<sup>3</sup>  
Kabellänge 2150mm

## LED SMD SAMSUNG TRIDONIC ON/OFF Transformatorinklusive

Leistung	Beam	Lumen	CCT	Ausführ.	Art-Nr.	€
36 W	105°	5050 lm	3000 K	Aluminiu.	192536	425
				Weiß	192550	425
				Schwarz	192567	425
		5300 lm	4000 K	Aluminiu.	192598	425
				Weiß	192604	425
				Schwarz	192628	425

## DIMMABLE DRIVER\* Optionals

	Leistung	Output	Maß (LxH xB)	Art-Nr.	€
1-10V	39 W	700 mA	280 x 21x 30 mm	216416	128
DALI/Push	38 W	700 mA	280 x 21x 30 mm	216270	145

## MOUNTING KIT Erforderlich - Seite 583



Light beam: WIDE

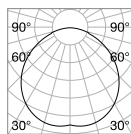

m	lx	Øm
1	1042	2,50
2	260	5,00
3	115	7,50
4	65	10,00
5	41	12,50

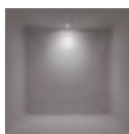

CRI≥83 27W 105° 3650lm 4000K

\* Dimmbare Treiber müssen mit dem Artikel mitbestellt werden und werden bei dem Produkt anstelle der on-off Treiber eingebaut. Kontinuierliche Lichtlinie ist nur für die Varianten on-off verfügbar.

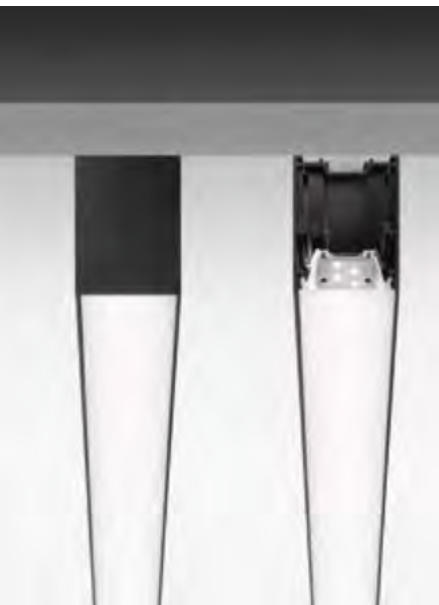

Fluo Wide 1200

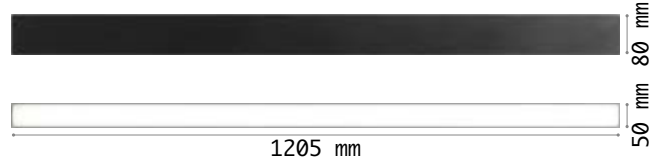

Fluo Wide 1800



Die einzelne Endkappe ist 2,5mmstark.

# Fluo Bi-Emission\*

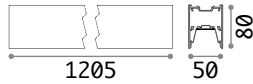

2,890 Kg/0,0183 m<sup>3</sup>  
Kabellänge 1800mm

## LED SMD SAMSUNG

Up-light inklusive – TRIDONIC ON/OFF Transformator inklusive

Leistung	Beam	Lumen	CCT	Ausführ.	Art-Nr.	€
27W	105°	3250 lm	3000 K	Aluminiu.	192659	425
				Weiß	192666	425
				Schwarz	192710	425
4050 lm	4000 K	4000 K	Aluminiu.	192734	425	
			Weiß	192741	425	
			Schwarz	192758	425	

## UP-LIGHT INFO

Leistung	Beam	Lumen	CCT
13W	105°	1750 lm	3000 K
		2050 lm	4000 K

## KIT DIMMABLE DRIVER\*

Art-Nr.	€	
1-10V	270692	230
DALI/Push	270876	260



4,420 Kg/0,0269 m<sup>3</sup>  
Kabellänge 1800mm

## LED SMD SAMSUNG

Up-light inklusive – TRIDONIC ON/OFF Transformator inklusive

Leistung	Beam	Lumen	CCT	Ausführ.	Art-Nr.	€
36W	105°	5050 lm	3000 K	Aluminiu.	192727	580
				Weiß	192703	580
				Schwarz	192697	580
5350 lm	4000 K	4000 K	Aluminiu.	192680	580	
			Weiß	192673	580	
			Schwarz	192642	580	

## UP-LIGHT INFO

Leistung	Beam	Lumen	CCT
18W	105°	2550 lm	3000 K
		2800 lm	4000 K

## KIT DIMMABLE DRIVER\*

Art-Nr.	€	
1-10V	270883	230
DALI/Push	270937	260



Light beam: BI-EMISSION  
WIDE

## MOUNTING KIT Erforderlich – Seite 583

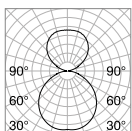

m	lx	øm
1	512	2,10
2	128	4,21
3	56	6,32
4	32	8,43
5	20	10,54



\* Direktes und indirektes Licht getrennt schaltbar (nur für Varianten on-off verfügbar). Direktes und indirektes Licht synchronisch dimmbar (dimmbare Varianten 1-10V und Push). Dimmbare Treiber müssen mit dem Artikel mitbestellt werden und werden bei dem Produkt anstelle der on-off Treiber eingebaut. Kontinuierliche Lichtlinie ist nur für die Varianten on-off verfügbar.

CRI ≥ 83 27+13W 105°+105° 3650+2350lm 3000K



Fluo Bi-Emission 1200

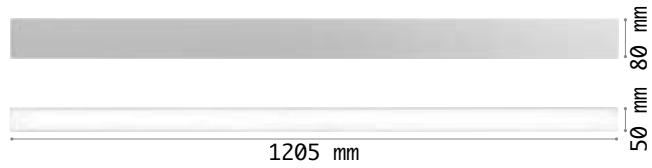

Fluo Bi-Emission 1800

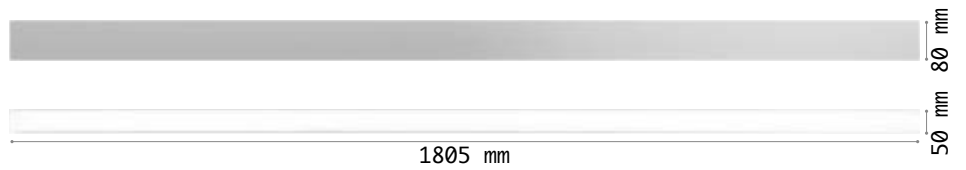

Die einzelne Endkappe ist 2,5mmstark.

# Fluo – Assembly plans

## FLUO SUSPENSION

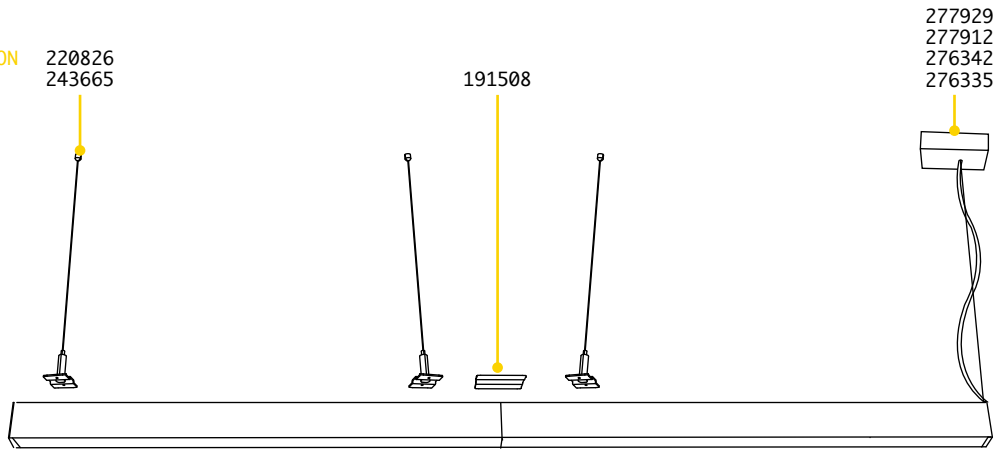

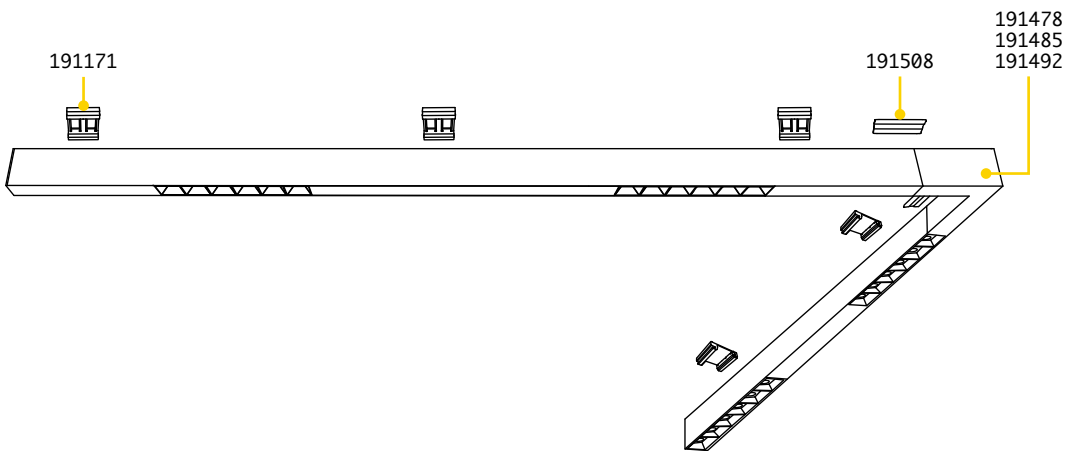

## FLUO SURFACE

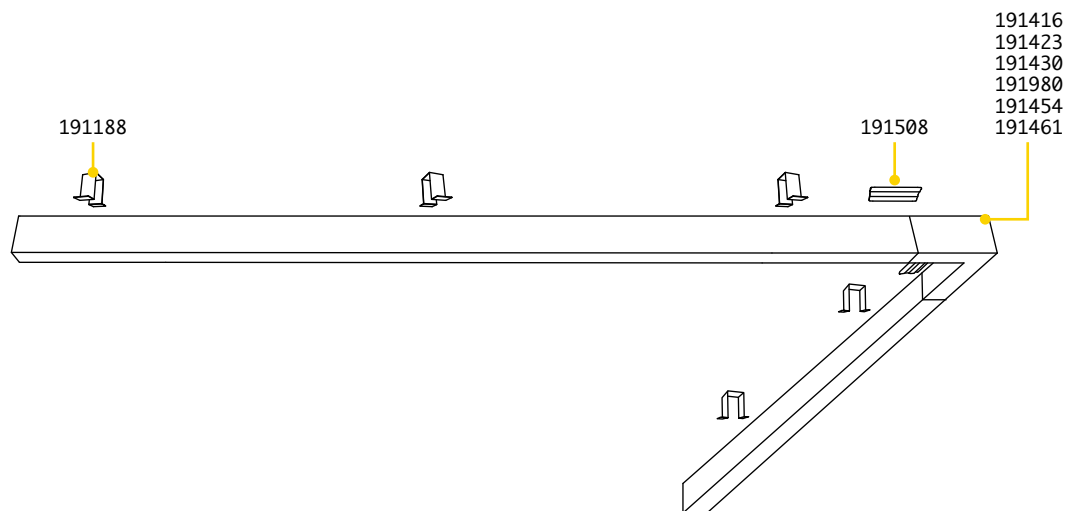

## FLUO RECESSED

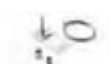

# Fluo – Mounting kit

	Erforderlich	Kabelanz.	Kabellänge	Ausführ.	Art.-Nr.	€
 <b>KIT SUSPENSION</b>	Ja – 1Kit x Stromanschlussp.	1	2000 mm	Weiß	277929	31
				Schwarz	277912	31
		1	5000 mm	Weiß	276342	43
				Schwarz	276335	43
 <b>KIT SINGLE CABLE</b>	Ja – 1Kit x 600 mm	1	2000 mm		220826	13
		1	5000 mm		243665	19
 <b>KIT RECESSED</b>	Ja – 1Kit x 600 mm				191188	37
 <b>KIT SURFACE</b>	Ja – 1Kit x 600 mm				191171	25

# Fluo – Optional

**CORNER** Optionals – ON/OFF Transformator inklusive – Mit Wide-Varianten kompatibel

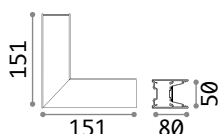

0,580 Kg/0,0023 m<sup>3</sup>

Leistung	Beam	Lumen	CCT	Ausführ.	Art.-Nr.	€
8W	105°	950 lm	3000 K	Aluminiu.	191416	95
				Weiß	191423	95
				Schwarz	191430	95
		1000 lm	4000 K	Aluminiu.	191980	95
				Weiß	191454	95
				Schwarz	191461	95

**BLINDED CORNER** Optionals – Mit Accent-Varianten kompatibel

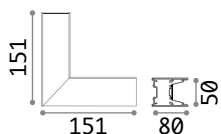

0,610 Kg/0,0023 m<sup>3</sup>

Ausführ.	Art.-Nr.	€
Aluminiu.	191478	65
Weiß	191485	65
Schwarz	191492	65

**STRUCTURE CONNECTOR** Max. Länge zu jedem Stromanschlusspunkt: 30 Meter



Erforderlich	Art.-Nr.	€
Ja – 1Kit x Verbindungs.	191508	12

# Steel

Linearleuchte aus Aluminium mit direktem und indirektem Licht mit Blendschutz zum Aufhängen. Indirektes Licht kann durch den am Rand des Geräts platzierten Schalter ein- oder ausgeschaltet werden. Die Leuchte ist in der Variante WIDE mit der diffus reflektierenden Downlight-Optik aus PMMA mikroprismatisch mit Blendschutz (UGR <19) und in der Variante ACCENT mit schwarzem Reflektor (UGR <16) verfügbar. LED-Lichtquellen integriert; in Farbtemperaturen 3000 K und 4000 K; CRI ≥90; lifetime 50.000 h L70B50; IP20. Für Büros, Gewerbe- und Verkaufsflächen geeignet.



Hightech-Produkt mit hochwertigen Materialien, gedacht für einen professionellen Einsatz.



Artikel mit UGR-Wert <16(Accent), <19(Wide).

Lichtquelle	LED SMD
Transformator	On/Off
inklusive	
Verfügbare	No
Transformatore	
MacAdam	SDCM 3
Abstrahlwinkel	Accent/Wide
CCT	3000 K / 4000 K
CRI	≥90
UGR	<16(Accent) / <19(Wide)
LED Lebensdauer	50.000 h
Schutzklasse	I
IP	20
Material	Aluminium
Garantie	5 Jahre







# Steel

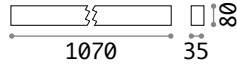
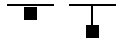

1,990 Kg/0,0178 m<sup>3</sup>  
Kabellänge 1800mm

## LEDSMDSAMSUNG

Up-light inklusive -OSRAM ON/OFF Transfor.inklusive-UGR <19

Leistung	Beam	Lumen	CCT	Ausführ.	Art-Nr.	€
36 W	70°	3350 lm	3000 K	Weiß	267128	290
				Schwarz	270197	290
		3550 lm	4000 K	Weiß	270203	290
				Schwarz	267135	290

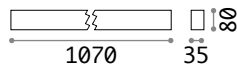

1,980 Kg/0,0178 m<sup>3</sup>  
Kabellänge 1800mm

## LEDSMDSAMSUNG

Up-light inklusive -OSRAM ON/OFF Transfor.inklusive-UGR <16

Leistung	Beam	Lumen	CCT	Ausführ.	Art-Nr.	€
36 W	60°	3000 lm	3000 K	Weiß	270180	345
				Schwarz	267142	345
		3200 lm	4000 K	Weiß	267159	345
				Schwarz	270173	345

## UP-LIGHT INFO

Ecke	Lumen	CCT
110°	1100 lm	3000 K
	1150 lm	4000 K



### KIT SUSPENSION

Erforderlich	Kabelanz.	Kabellänge	Ausführ.	Art-Nr.	€
Ja -1Kit x Stromanschlusssp.	1	2000 mm	Weiß	276311	28
			Schwarz	276304	28



### KIT SINGLE CABLE

Ja -1Kit x 500 mm	1	2000 mm		271750	13
-------------------	---	---------	--	--------	----



### KIT SURFACE

Ja -1Kit x 1000mm				270210	31
-------------------	--	--	--	--------	----



### KIT CONTINUOS

Ja -1Kit x Verbindungs.				271712	7
-------------------------	--	--	--	--------	---



Light beam: BI-EMISSION ACCENT



Light beam: BI-EMISSION WIDE

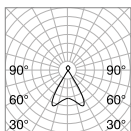

m	lx	Øm
1	2216	1,20
2	554	2,40
3	246	3,60
4	139	4,80
5	89	6,10

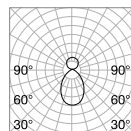
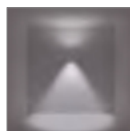

m	lx	Øm
1	1173	1,50
2	293	3,10
3	130	4,60
4	73	6,20
5	47	7,70



CRI≥90 36W 70° 2770lm 4000K

CRI≥90 36W 60° 2680lm 4000K



Steel Accent

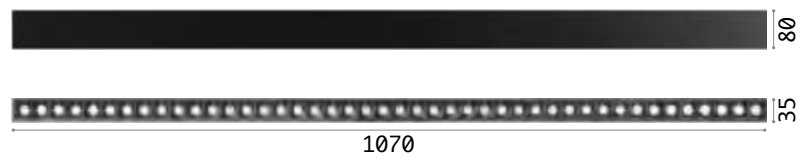

Steel Wide

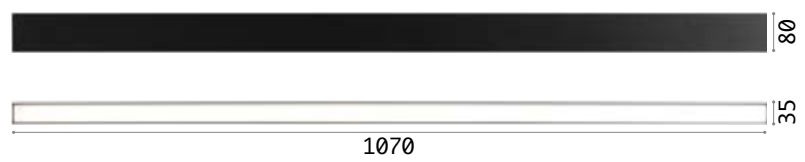

# Office



Linearleuchte aus Aluminium mit direktem Licht zum Aufhängen. In Weiß oder Schwarz erhältlich mit schwarzen Reflektoren. LED-Lichtquellen integriert mit Blendschutz (UGR <16); in Farbtemperaturen 3000 K und 4000 K erhältlich; CRI ≥ 80; 30.000 Std. Betrieb L70B50; Schutzart IP20; Schutzklasse I.

Lichtquelle	LED SMD	CRI	≥80
Leistung	30W	UGR	<16
Transformator	On/Off	LED Lebensdauer	50.000 h
inklusive		Schutzklasse	I
Verfügbare	No	IP	20
Transformatore		Material	Aluminium
CCT	3000 K / 4000 K	Garantie	5 Jahre

**UGR** Artikel mit UGR-Wert <16.

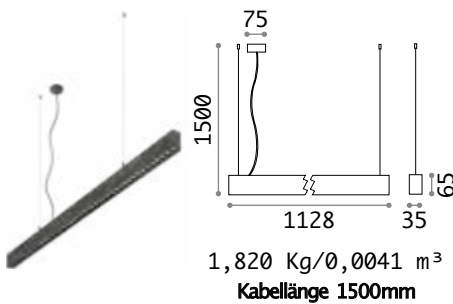

## LED SMD ON/OFF Transfor.inklusive

Leistung	Beam	Lumen	CCT	Ausführ.	Art.-Nr.	€
30 W	37°	2800 lm	3000 K	Weiß	271194	188
				Schwarz	271187	188
30 W	37°	3100 lm	4000 K	Weiß	271217	188
				Schwarz	271200	188



Light beam: ACCENT

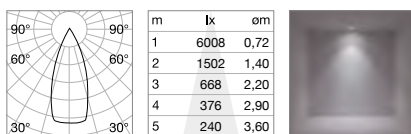

CRI≥80 30W 37° 3100lm 4000K



271194

271187

Flexibles Stahlband für eine Wand zu Wand Montage, als Halter zur Montage von Strip-Leds verwendet, Lichtquelle für indirektes Licht. Max. Länge 5 oder 10Mt. Der minimale Abschnitt, der im Raum verschwindet, erlaubt ein extrem formales, sauberes Ergebnis. Erhältlich in den Ausführungen Stahl, Weiß oder Schwarz. Ideal für Räume, die bereits mit historischem und architektonischem Charakter stark eingerichtet sind.

## STRIP LED SUPPORT

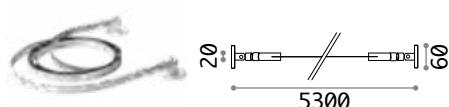

Länge	Gewicht	Volumen	Ausführ.	Art.-Nr.	€
5000 mm	0,35 Kg	0,0234 m <sup>3</sup>	Stahl	258300	130
			Weiß	302256	130 <small>new</small>
			Schwarz	302263	130 <small>new</small>



Länge	Gewicht	Volumen	Ausführ.	Art.-Nr.	€
10000 mm	0,45 Kg	0,0029 m <sup>3</sup>	Stahl	302270	165 <small>new</small>
			Weiß	302287	165 <small>new</small>
			Schwarz	302294	165 <small>new</small>

## STRIP LED AND DRIVER Erforderlich –Seite 814

### RECOMMENDED STRIP LED AND DRIVER

#### STRIP LED SMD 2835 120LED/m CRI $\geq$ 90

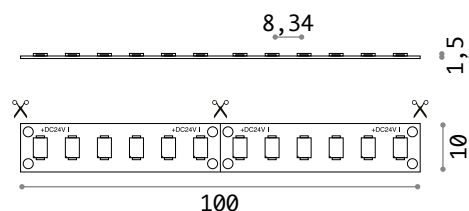

Leistung	IP	Lumen	CCT	Länge	Art.-Nr.	€
15W/m	IP20	1370lm/m	2700 K	5000 mm	272498	50
		1400lm/m	3000 K	5000 mm	272481	50
		1450lm/m	4000 K	5000 mm	272474	50
	IP65	1400lm/m	3000 K	5000 mm	272504	65
		1450lm/m	4000 K	5000 mm	287959	65

## DRIVER ON/OFF



Light beam: INDIRECT



Driver	Leistung	Output	Klasse	Maß (L x H x B)	Art.-Nr.	€
On-Off	30 W	24 Vdc	□	140x28x45 mm	124070	1750
	60 W	24 Vdc	□	186x33x50 mm	124087	30
	150 W	24 Vdc	⊕	268 x31x45 mm	124117	50

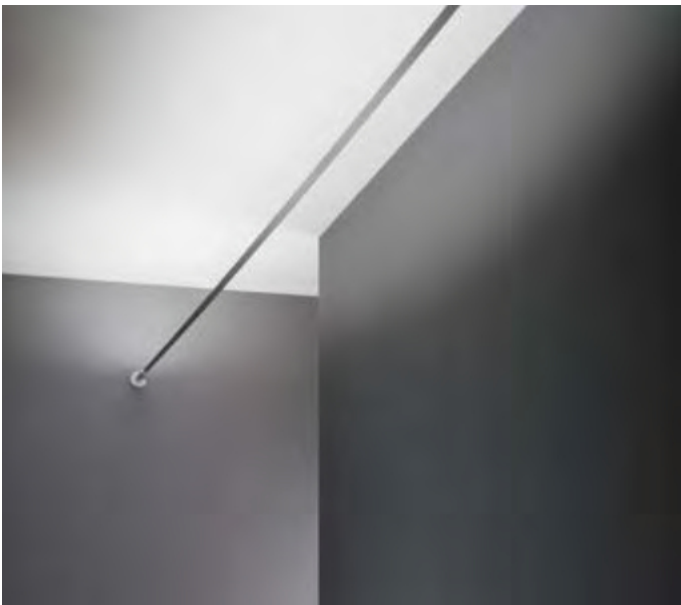

# Vision

Profil aus extrudiertem Aluminium mit Oberfläche eloxiert und pulverlackiert, in Weiß und Schwarz verfügbar, Lichtverteiler aus PMMA satiniert. Stäbe verschiedener Längen bei der Variante TRIM für randlosen Einbau in Gipskartondecken und bei der Variante TRIMLESS für Wand- oder Deckenmontage erhältlich; Aufhängungskit verfügbar. Die Linearprofile sind in den Längen 2000 und 3000 mm lieferbar, je nach gewünschter Zeichnung kombinierbar und aufteilbar. Strip LED und Driver für eine korrekte Installation zuordnen: Lichtquellen lieferbar in den Lichtfarben 3000K und 4000K; CRI  $\geq 90$  und Schutzgrad IP20. Dank der hohen Flexibilität ist der System zur allgemeinen Beleuchtung von GEWERBE- und VERKAUFSS-Flächen geeignet.

Variante	Trim /Trimless
Länge	2000 /3000 mm
Material	Aluminium







# Vision Trimless

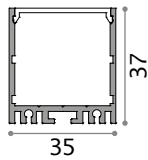

## PROFILE Montagekit inklusive

Länge	Gewicht	Volumen	Ausführ.	Art.-Nr.	€
2000 mm	1,40Kg	0,0032 m <sup>3</sup>	Weiß	270524	65
	1,40Kg	0,0032 m <sup>3</sup>	Schwarz	270517	65
3000 mm	2,10Kg	0,0048 m <sup>3</sup>	Weiß	270548	95
	2,10Kg	0,0048 m <sup>3</sup>	Schwarz	270531	95



## SUSPENSION KIT

Erforderlich	Kabelanz.	Kabellänge	Art.-Nr.	€
Nein-1Kitx2000mm	2	3000 mm	270449	16
Nein-1Kitx2000mm	2	5000 mm	270456	20



## STRUCTURE CONNECTOR

Ja -1Kit xVerbindungs.			270463	5
------------------------	--	--	--------	---

## STRIP LED AND DRIVER Erforderlich -Seite 814

Empfohlenes Strip LED max 39 W/m

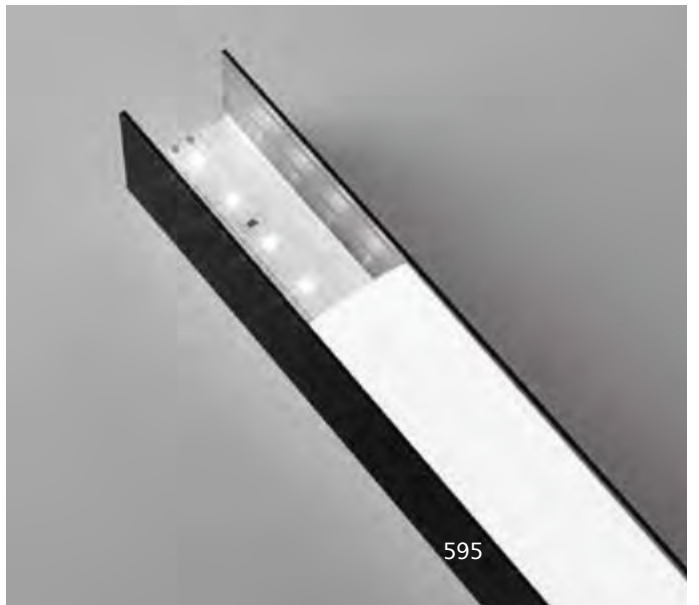

# Vision Trim

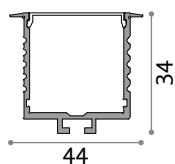
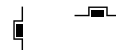

## PROFILE Montagekit inklusive

Länge	Gewicht	Volumen	Ausführ.	Art.-Nr.	€
2000 mm	1,26Kg	0,0050 m <sup>3</sup>	Weiß	270487	70
	1,26Kg	0,0050 m <sup>3</sup>	Schwarz	270470	70
3000 mm	1,89Kg	0,0075 m <sup>3</sup>	Weiß	270500	105
	1,89Kg	0,0075 m <sup>3</sup>	Schwarz	270494	105



## STRUCTURE CONNECTOR

Erforderlich	Art.-Nr.	€
Ja -1Kit xVerbindungs.	271125	5

## STRIP LED AND DRIVER Erforderlich -Seite 814

Empfohlenes StripLED max 39 W/m

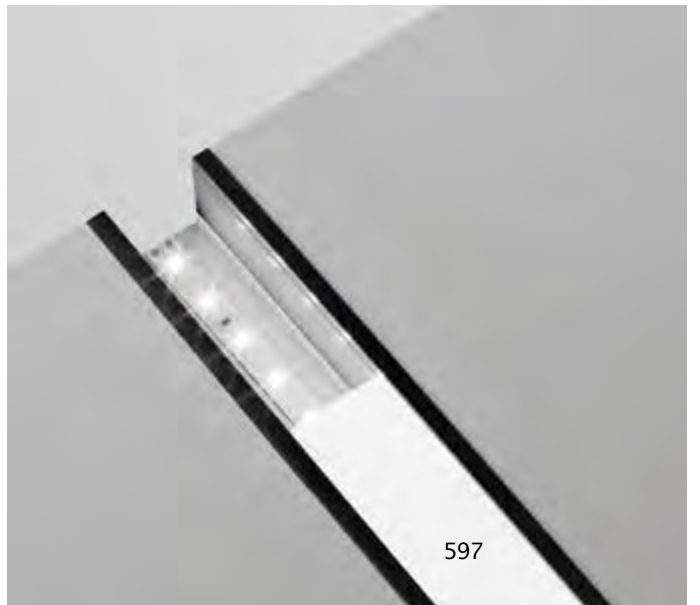

# Slot <sup>new</sup>

Profil aus extrudiertem Aluminium mit Oberfläche eloxiert oder pulverlackiert, in Weiß, Schwarz und Aluminium verfügbar, Lichtverteiler aus PMMA satiniert. Stäbe verschiedener Schnitten und Längen bei der Variante RECESSED für randlosen Einbau in Gipskartondecken und bei der Variante SURFACE für Wand- oder Deckenmontage erhältlich. Die Modelle ANGULAR in rund und quadratisch sind mit einem inneren Neigungswinkel der Lichtquelle für die Konzipiert. Die Linearprofile sind in den Längen 1000, 2000 oder 3000 mm lieferbar, je nach gewünschter Zeichnung kombinierbar und aufteilbar. Strip LED und Driver für eine korrekte Installation zuordnen: Lichtquellen lieferbar in den Lichtfarben 2700K, 3000K, 4000K; CRI  $\geq 80$ ,  $\geq 85$  und  $\geq 90$ ; Schutzgrad IP20 oder IP65.

Variante	Recessed /Surface /Angular
Breite	12 /14/15 /16/ 20 /31mm
Material	Aluminium





# Slot Recessed

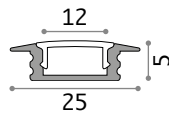

## PROFILE 12mm Montagekit inklusive

Länge	Gewicht	Volumen	Ausführ.	Art-Nr.	€
1000 mm	0,15Kg	0,0010 m <sup>3</sup>	Weiß	124155	16
2000 mm	0,35 Kg	0,0020 m <sup>3</sup>	Weiß	203102	27
3000 mm	0,54 Kg	0,0029 m <sup>3</sup>	Weiß	204611	40

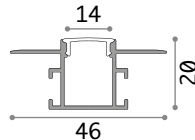

## PROFILE 14mm

Länge	Gewicht	Volumen	Ausführ.	Art-Nr.	€
2000 mm	0,65 Kg	0,0020 m <sup>3</sup>	Weiß	223704	62
3000 mm	0,90 Kg	0,0029 m <sup>3</sup>	Weiß	223711	98

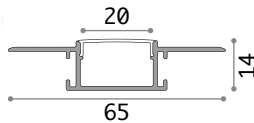

## PROFILE 20mm

Länge	Gewicht	Volumen	Ausführ.	Art-Nr.	€
2000 mm	0,60 Kg	0,0020 m <sup>3</sup>	Weiß	223728	73
3000 mm	0,90 Kg	0,0029 m <sup>3</sup>	Weiß	223735	107

## KIT PROFILE 14/20mm



KIT LINEAR

KIT RIGHT-LEFT

KIT VERTICAL-HORIZONTAL

Erforderlich	Art-Nr.	€
Ja -1Kit x Verbindungs.	223766	6
Ja -1Kit x Verbindungs.	223759	6
Ja -1Kit x Verbindungs.	223742	6

## STRIP LED AND DRIVER Erforderlich -Seite 858

Empfohlenes StripLED max 14,4 W/m



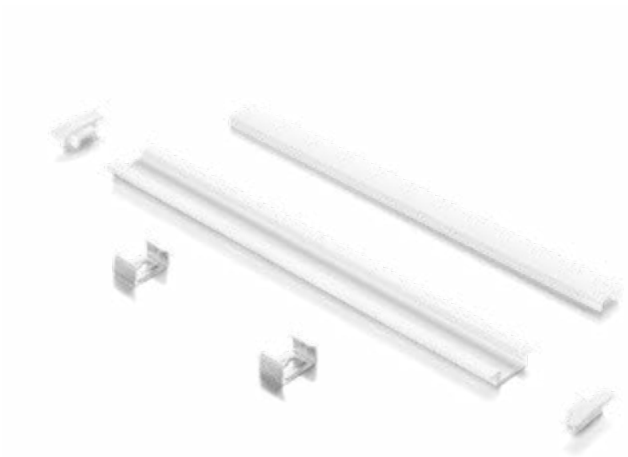
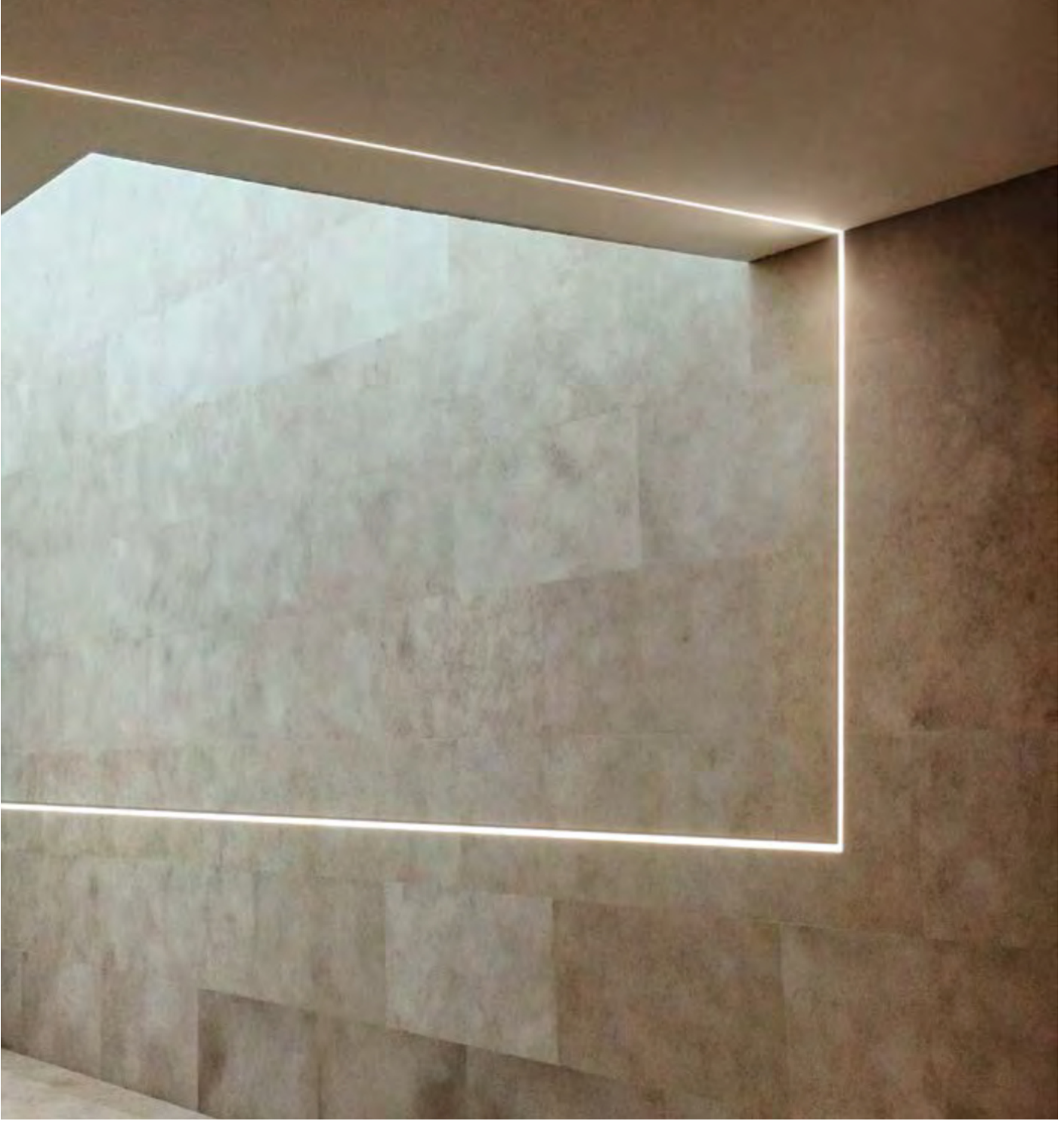

Montagekit PROFILE 12mm.



223728  
223735

601

# Slot Surface

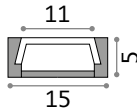

## PROFILE 15mm Montagekit inklusive

Länge	Gewicht	Volumen	Ausführ.	Art.-Nr.	€
1000 mm	0,15Kg	0,0010 m <sup>3</sup>	Weiß	124131	13
	0,15Kg	0,0010 m <sup>3</sup>	Aluminiu.	124124	13
2000 mm	0,20 Kg	0,0020 m <sup>3</sup>	Weiß	203089	22
	0,20 Kg	0,0020 m <sup>3</sup>	Aluminiu.	203072	22
3000 mm	0,34 Kg	0,0029 m <sup>3</sup>	Weiß	204598	32
	0,34 Kg	0,0029 m <sup>3</sup>	Aluminiu.	204581	32

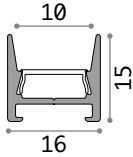

## PROFILE 16mm Montagekit inklusive

Länge	Gewicht	Volumen	Ausführ.	Art.-Nr.	€
2000 mm	0,20 Kg	0,0015 m <sup>3</sup>	Weiß	307145	25 <small>new</small>
			Schwarz	296463	25 <small>new</small>

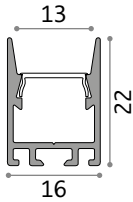

## PROFILE 16mm Montagekit inklusive

Länge	Gewicht	Volumen	Ausführ.	Art.-Nr.	€
2000 mm	0,40 Kg	0,0021m <sup>3</sup>	Weiß	307152	29 <small>new</small>
			Schwarz	296456	29 <small>new</small>



COVER 16mm

Erforderlich	Ausführ.	Art.-Nr.	€
Nein	Schwarz	307251	6 <small>new</small>

STRIP LED AND DRIVER **Erforderlich – Seite 858**

Empfohlenes StripLED max 14,4 W/m



Montagekit PROFILE 15mm.



# Slot Angular

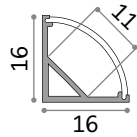

## ROUND 16x16

Länge	Gewicht	Volumen	Ausführ.	Art.-Nr.	€
1000 mm	0,15Kg	0,0010 m <sup>3</sup>	Weiß	126548	12
	0,15Kg	0,0010 m <sup>3</sup>	Aluminiu.	126531	12
2000 mm	0,30 Kg	0,0020 m <sup>3</sup>	Weiß	203126	28
	0,30 Kg	0,0020 m <sup>3</sup>	Aluminiu.	203119	28
3000 mm	0,44 Kg	0,0030 m <sup>3</sup>	Weiß	204635	40
	0,44 Kg	0,0030 m <sup>3</sup>	Aluminiu.	204628	40

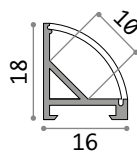

## ROUND 16x18

Länge	Gewicht	Volumen	Ausführ.	Art.-Nr.	€
2000 mm	0,30 Kg	0,0020 m <sup>3</sup>	Weiß	267401	24
	0,30 Kg	0,0020 m <sup>3</sup>	Aluminiu.	267395	24
3000 mm	0,45 Kg	0,0029 m <sup>3</sup>	Weiß	267425	38
	0,45 Kg	0,0029 m <sup>3</sup>	Aluminiu.	267418	38

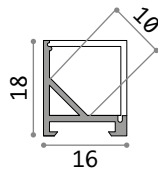

## SQUARE 16x18

Länge	Gewicht	Volumen	Ausführ.	Art.-Nr.	€
2000 mm	0,30 Kg	0,0020 m <sup>3</sup>	Weiß	267449	26
	0,30 Kg	0,0020 m <sup>3</sup>	Aluminiu.	267432	26
3000 mm	0,45 Kg	0,0029 m <sup>3</sup>	Weiß	267463	38
	0,45 Kg	0,0029 m <sup>3</sup>	Aluminiu.	267456	38

## STRIP LED AND DRIVER Erforderlich –Seite 814

Empfohlenes StripLED max 14,4 W/m

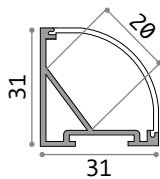

## ROUND 31x31

Länge	Gewicht	Volumen	Ausführ.	Art.-Nr.	€
2000 mm	0,70Kg	0,0020 m <sup>3</sup>	Weiß	267722	32
	0,70Kg	0,0020 m <sup>3</sup>	Aluminiu.	267715	32
3000 mm	1,05Kg	0,0029 m <sup>3</sup>	Weiß	267746	44
	1,05Kg	0,0029 m <sup>3</sup>	Aluminiu.	267739	44

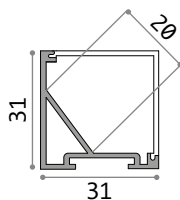

## SQUARE 31x31

Länge	Gewicht	Volumen	Ausführ.	Art.-Nr.	€
2000 mm	0,70Kg	0,0020 m <sup>3</sup>	Weiß	267487	35
	0,70Kg	0,0020 m <sup>3</sup>	Aluminiu.	267470	35
3000 mm	1,05Kg	0,0029 m <sup>3</sup>	Weiß	267500	50
	1,05Kg	0,0029 m <sup>3</sup>	Aluminiu.	267494	50

## STRIP LED AND DRIVER Erforderlich –Seite 858

Empfohlenes StripLED max 14,4 W/m



Montagekit PROFILE 16x16mm.



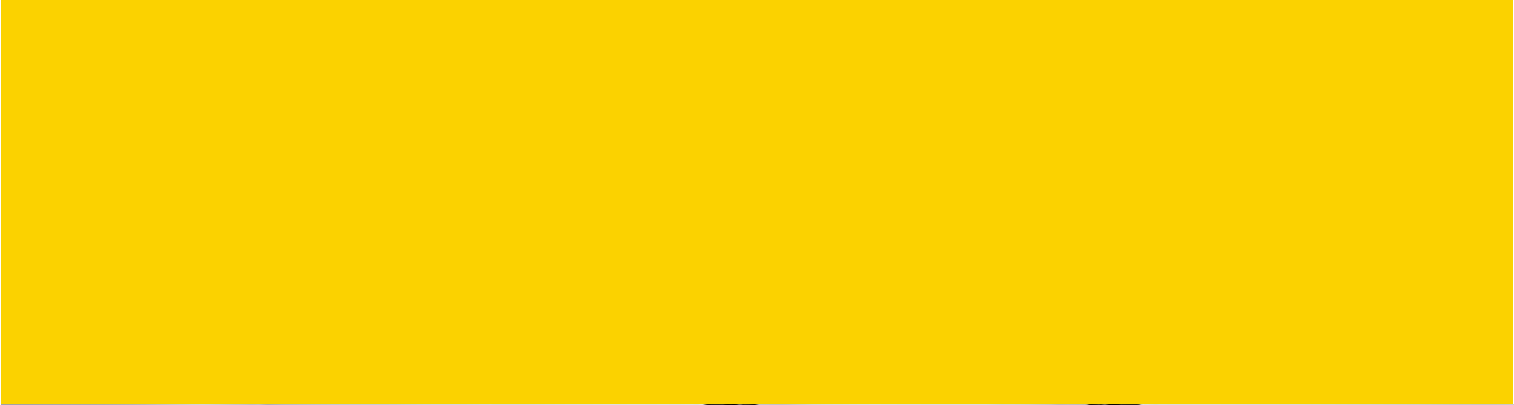

# Innenräume















## Strahler und Schienen



### Alphabetisches inhalt

Byte	639
Display	642
Eos	632
Fox	624
Glim	640
Konig	640
Link	650
Look	641
Mouse	638
Pov	636
Quick	608
Smile	616
Spot	638

### Inhalt Typen

		
Quick 608	Smile 616	Fox 624
		
Eos 632	Pov 636	Mouse 638
		
Spot 638	Byte 639	Glim 640
		
Konig 640	Look 641	
		
DisplayAccent 644	DisplayWide 646	DisplayUGR 648
		
Link 650		

# Quick

Zylindrischer Strahler aus extrudiertem Aluminium zum Einsatz in 3-Phasen-Schiene geeignet. Pulverlackiert in weiß oder schwarz; 355° dreh- und 90° schwenkbar; Driver inklusive, im zylindrischen Körper des Strahlers enthalten. Auch in dimmbarer 1-10 V- oder DALI-Version erhältlich. Lichtquelle mit integrierter COB LED Technologie für höchste Effizienz; lieferbar in den Lichtfarben 3000K und 4000K; hocheffiziente LED mit guter Farbwiedergabe, bis zu CRI  $\geq 90$ ; Binning initial  $\leq 3$ -Step MacAdam; symmetrisch strahlende Optik mit drei verschiedenen Ausstrahlwinkeln und gute Entblendung (UGR < 19); Montage und Demontage werkzeuglos; Schutzart IP20; Schutzklasse I; Lebensdauer LED 50.000h L80B50. Ideal für große Räume, wo nach guter Flexibilität und Farbwiedergabe gesucht wird, wie z.B. MUSEUMS-, GEWERBE- und RETAILRÄUME.

**PRO** Hightech-Produkt mit hochwertigen Materialien, gedacht für einen professionellen Einsatz.

Lichtquelle	LEDCOB
Leistung	15W / 21W / 28W
Transformator	On/Off / 1-10V / DALI
inklusive	
Verfügbare	No
Transformatore	
Schiene	3-Phasen (standard Eutrac)
MacAdam	SDCM 3
CCT	3000 K / 4000 K
CRI	$\geq 80$ / $\geq 90$
LED Lebensdauer	50.000h
Schutzklasse	I
IP	20
Material	Aluminium
Garantie	5 Jahre



Link-Seite 650







# Quick 15W



## LED COB CITIZEN

CRI ≥ 80

Leistung	Beam	Transfor.	Lumen	CCT	Ausführ.	Art.-Nr.	€	
15W	30°	On-Off	1800 lm	3000 K	Weiß	222509	145	
					Schwarz	222523	145	
		1-10V	1800 lm	3000 K	Weiß	222530	145	
					Schwarz	222547	145	
			DALI	1800 lm	3000 K	Weiß	249643	195
						Schwarz	247861	195
DALI	1800 lm	3000 K	Weiß	249681	220			
			Schwarz	246437	220			

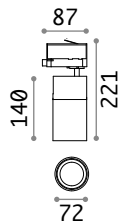

CRI ≥ 90

Leistung	Beam	Transfor.	Lumen	CCT	Ausführ.	Art.-Nr.	€
15W	30°	On-Off	1550 lm	3000 K	Weiß	222554	145
					Schwarz	222561	145
			1700 lm	4000 K	Weiß	222578	145
					Schwarz	222585	145

0,760 Kg/0,0038 m<sup>3</sup>

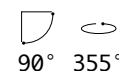

Erforderlich	Beam	Transform.	Ausführ.	Art.-Nr.	€
Nein			Schwarz	222608	9
Nein	15°		Transpar.	222592	9
Nein	45°		Transpar.	253558	9
Nein		On/Off	Weiß	170145	27
Nein			Schwarz	170152	27
Nein		DALI/1-10V	Weiß	247649	29
Nein			Schwarz	247632	29



FILTER HONEYCOMB



LENS\*



SINGLE CONNECTION



Light beam: ACCENT

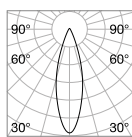

m	lx	øm
1	3451	0,51
2	862	1,02
3	383	1,53
4	215	2,04
5	138	2,55

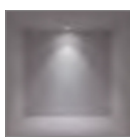

CRI ≥ 80 15W 30° 1900lm 3000K

\* Das Objektiv muss zusammen mit dem Produkt bestellt werden und wird anstelle des mitgelieferten Standardobjektivs im Produkt montiert.

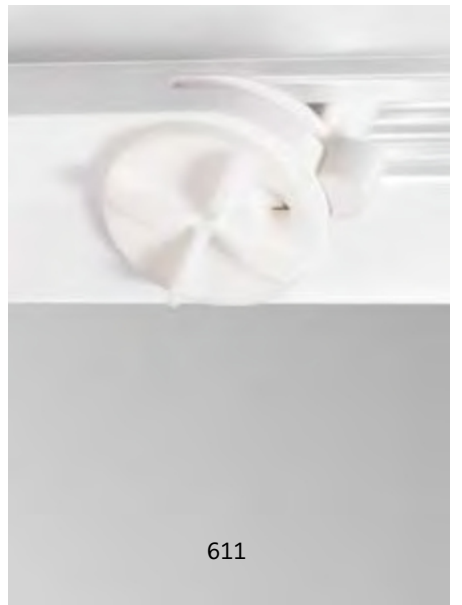

# Quick 21W



## LED COB CITIZEN

CRI ≥ 80

Leistung	Beam	Transfor.	Lumen	CCT	Ausführ.	Art.-Nr.	€
21W	30°	On-Off	2450 lm	3000 K	Weiß	247946	155
					Schwarz	247939	155
			2700 lm	4000 K	Weiβ	247960	155
		1-10V	2450 lm	3000 K	Weiβ	249650	230
					Schwarz	247878	230
			DALI	2450 lm	3000 K	Weiβ	249698
					Schwarz	246444	260

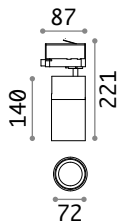

CRI ≥ 90

Leistung	Beam	Transfor.	Lumen	CCT	Ausführ.	Art.-Nr.	€
21W	30°	On-Off	2150 lm	3000 K	Weiβ	247977	155
					Schwarz	225364	155
			2350 lm	4000 K	Weiβ	247991	155
					Schwarz	247984	155

0,760 Kg/0,0038 m<sup>3</sup>

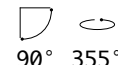

## FILTER HONEYCOMB



## LENS\*



## SINGLE CONNECTION

Erforderlich	Beam	Transform.	Ausführ.	Art.-Nr.	€
Nein			Schwarz	222608	9
Nein	15°		Transpar.	222592	9
Nein	45°		Transpar.	253558	9
Nein		On/Off	Weiβ	170145	27
Nein			Schwarz	170152	27
Nein		DALI/1-10V	Weiβ	247649	29
Nein			Schwarz	247632	29



Light beam: ACCENT

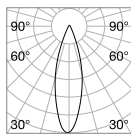

m	lx	Øm
1	6576	0,57
2	1644	1,14
3	731	1,71
4	411	2,28
5	263	2,85

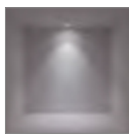

CRI ≥ 80 21W 30° 2650lm 3000K

\* Das Objektiv muss zusammen mit dem Produkt bestellt werden und wird anstelle des mitgelieferten Standardobjektivs im Produkt montiert.

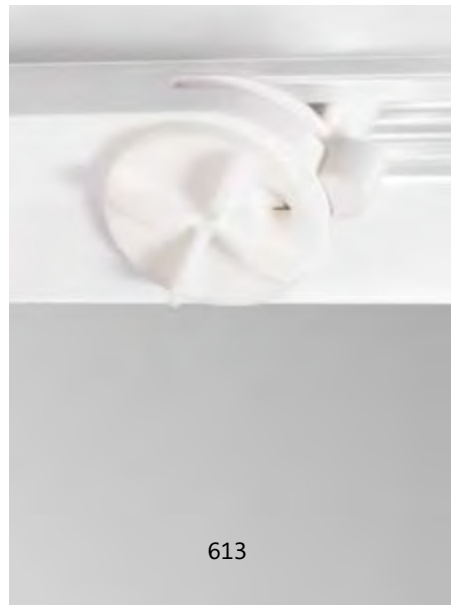

# Quick 28W

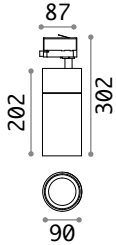

90° 355°  
1,200 Kg/0,0063 m<sup>3</sup>

## LED COB CITIZEN

CRI ≥ 80

Leistung	Beam	Transfor.	Lumen	CCT	Ausführ.	Art.-Nr.	€	
28 W	30°	On-Off	3550 lm	3000 K	Weiß	222615	185	
					Schwarz	222622	185	
		1-10V	3800 lm	4000 K	Weiß	222639	185	
					Schwarz	222646	185	
			DALI	3550 lm	3000 K	Weiß	249674	250
						Schwarz	247885	250
DALI	3550 lm	3000 K	Weiß	249704	310			
			Schwarz	246413	310			

CRI ≥ 90

Leistung	Beam	Transfor.	Lumen	CCT	Ausführ.	Art.-Nr.	€
28 W	30°	On-Off	3100 lm	3000 K	Weiß	222653	185
					Schwarz	222660	185
			3300 lm	4000 K	Weiß	222677	185
					Schwarz	222684	185



FILTER HONEYCOMB

LENS\*

SINGLE CONNECTION

Erforderlich	Beam	Transform.	Ausführ.	Art.-Nr.	€
Nein			Schwarz	222714	10
Nein	18°		Transpar.	222691	10
Nein	45°		Transpar.	222707	10
Nein		On/Off	Weiß	170145	27
Nein			Schwarz	170152	27
Nein		DALI/1-10V	Weiß	247649	29
Nein			Schwarz	247632	29



Light beam: ACCENT

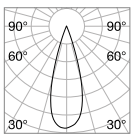

m	lx	om
1	8760	0,55
2	2190	1,11
3	973	1,67
4	547	2,22
5	350	2,78

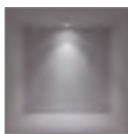

CRI ≥ 80 28W 30° 3850lm 3000K

\* Das Objektiv muss zusammen mit dem Produkt bestellt werden und wird anstelle des mitgelieferten Standardobjektivs im Produkt montiert.

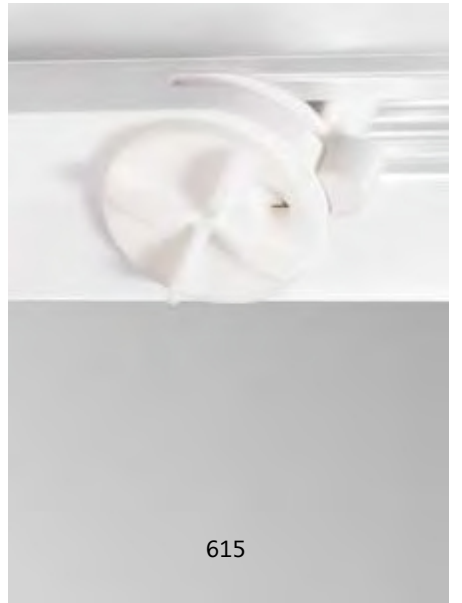

# Smile

Zylindrischer Strahler aus Aluminium (Extrusion +CNC Steuerung +Schmieden) zum Einsatz in 3-Phasen-Schiene geeignet. Pulverlackiert in weiß oder schwarz; 350° dreh- und 90° schwenkbar; Driver inklusive, im zylindrischen Körper des Strahlers enthalten; Lichtquelle mit integrierter COB LED Technologie; lieferbar in den Lichtfarben 3000 K und 4000 K und CRI bis zu 90; Binning initial ≤4-Step MacAdam; symmetrisch strahlende Optik mit drei verschiedenen Ausstrahlwinkeln und gute Entblendung (UGR<19); Montage und Demontage werkzeuglos; Schutzart IP20; Schutzklasse II; Lebensdauer LED 50.000h L70B50. Ideal für große Räume, wo nach guter Flexibilität und Farbwiedergabe gesucht wird, wie z.B. MUSEUMS-, GEWERBE- und RETAILRÄUME.

**UGR** Artikel mit UGR-Wert <19.

Lichtquelle	LEDCOB
Leistung	15W /20W /30W
Transformator	On/Off
inklusive	
Verfügbare	No
Transformatore	
Schiene	3-Phasen(standard Eutrac)
CCT	3000 K /4000 K
CRI	≥82 /≥92
LED Lebensdauer	50.000h
Schutzklasse	II
IP	20
Material	Aluminium
Garantie	5 Jahre



[Link -Seite 650](#)







# Smile 15W

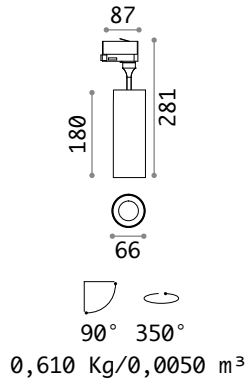

LED COB PHILIPS TRIDONIC ON/OFF Transformatorinklusive

CRI ≥ 82

Leistung	Beam	Lumen	CCT	Ausführ.	Art-Nr.	€
15W	24°	2050 lm	3000 K	Weiß	189574	120
				Schwarz	189581	120
	36°	2250 lm	4000 K	Weiß	189611	120
				Schwarz	189628	120
		2050 lm	3000 K	Weiß	189758	120
				Schwarz	189765	120
	50°	2250 lm	4000 K	Weiß	189796	120
				Schwarz	189802	120
		2050 lm	3000 K	Weiß	189932	120
				Schwarz	189949	120
	2250 lm	4000 K	Weiß	189956	120	
			Schwarz	189963	120	

CRI ≥ 92

Leistung	Beam	Lumen	CCT	Ausführ.	Art-Nr.	€
15W	24°	1700 lm	3000 K	Weiß	189598	120
				Schwarz	189604	120
	36°	1700 lm	3000 K	Weiß	189772	120
				Schwarz	189789	120
	50°	1700 lm	3000 K	Weiß	189970	120
				Schwarz	189987	120



FILTER HONEYCOMB

FILTER ELLIPTICAL

RING

SINGLE CONNECTION

Erforderlich	Transform.	Ausführ.	Art-Nr.	€
Nein		Schwarz	189536	6
Nein		Transpar.	189543	8
Nein		Weiß	189505	15
Nein	On/Off	Weiß	170145	27
		Schwarz	170152	27



Light beam: SPOT



Light beam: ACCENT



Light beam: WIDE

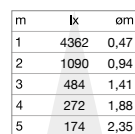
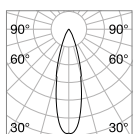

CRI ≥ 82 15W 24° 1600lm 3000K

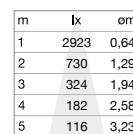
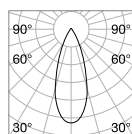

CRI ≥ 82 15W 36° 1600lm 3000K

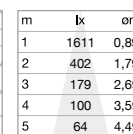
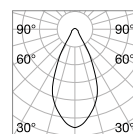

CRI ≥ 82 15W 50° 1600lm 3000K



# Smile 20W

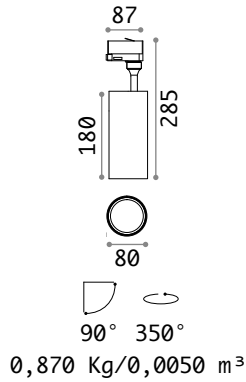

LED COB PHILIPS TRIDONIC ON/OFF Transformatorinklusive

CRI ≥ 82

Leistung	Beam	Lumen	CCT	Ausführ.	Art.-Nr.	€
20 W	24°	3000 lm	3000 K	Weiß	189635	135
				Schwarz	189642	135
	36°	3000 lm	3000 K	Weiß	189673	135
				Schwarz	189680	135
		3150 lm	4000 K	Weiß	189819	135
				Schwarz	189826	135
	50°	3000 lm	3000 K	Weiß	189857	135
				Schwarz	189864	135
		3150 lm	4000 K	Weiß	189994	135
				Schwarz	190006	135
		3150 lm	4000 K	Weiß	190013	135
				Schwarz	190020	135

CRI ≥ 92

Leistung	Beam	Lumen	CCT	Ausführ.	Art.-Nr.	€
20 W	24°	2550 lm	3000 K	Weiß	189659	135
				Schwarz	189666	135
	36°	2550 lm	3000 K	Weiß	189833	135
				Schwarz	189840	135
	50°	2550 lm	3000 K	Weiß	190037	135
				Schwarz	190044	135



FILTER HONEYCOMB

FILTER ELLIPTICAL

RING

SINGLE CONNECTION

Erforderlich	Transform.	Ausführ.	Art.-Nr.	€
Nein		Schwarz	190181	6
Nein		Transpar.	190259	9
Nein		Weiß	189529	13
Nein	On/Off	Weiß	170145	27
		Schwarz	170152	27



Light beam: SPOT



Light beam: ACCENT



Light beam: WIDE

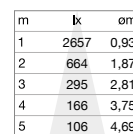
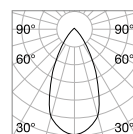
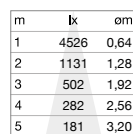
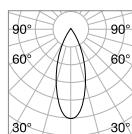
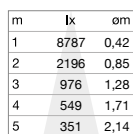
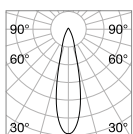

CRI ≥ 82 20W 24° 2350lm 3000K

CRI ≥ 82 20W 36° 2350lm 3000K

CRI ≥ 82 20W 50° 2350lm 3000K



# Smile 30W

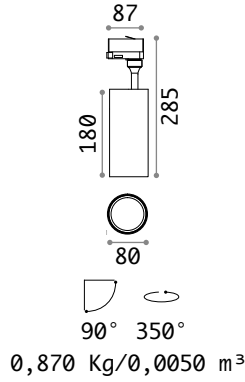

## LED COB PHILIPS TRIDONIC ON/OFF Transformatorinklusive

### CRI ≥ 82

Leistung	Beam	Lumen	CCT	Ausführ.	Art.-Nr.	€
30 W	24°	4000 lm	3000 K	Weiß	189697	150
				Schwarz	189703	150
		4200 lm	4000 K	Weiß	189734	150
				Schwarz	189741	150
	36°	4000 lm	3000 K	Weiß	189871	150
				Schwarz	189888	150
		4200 lm	4000 K	Weiß	189895	150
				Schwarz	189901	150
	50°	4000 lm	3000 K	Weiß	190051	150
				Schwarz	190068	150
		4200 lm	4000 K	Weiß	190075	150
				Schwarz	190082	150

### CRI ≥ 92

Leistung	Beam	Lumen	CCT	Ausführ.	Art.-Nr.	€
30 W	24°	3500 lm	3000 K	Weiß	189710	150
				Schwarz	189727	150
	36°	3500 lm	3000 K	Weiß	189918	150
				Schwarz	189925	150
	50°	3500 lm	3000 K	Weiß	190099	150
				Schwarz	190105	150



FILTER HONEYCOMB

FILTER ELLIPTICAL

RING

SINGLE CONNECTION

Erforderlich	Transform.	Ausführ.	Art.-Nr.	€
Nein		Schwarz	190181	6
Nein		Transpar.	190259	9
Nein		Weiß	189529	13
Nein	On/Off	Weiß	170145	27
		Schwarz	170152	27



Light beam: SPOT



Light beam: ACCENT



Light beam: WIDE

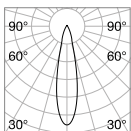

m	lx	øm
1	12955	0,39
2	3238	0,79
3	1439	1,19
4	809	1,59
5	518	1,99

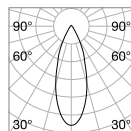

m	lx	øm
1	6240	0,62
2	1560	1,24
3	693	1,86
4	390	2,48
5	249	3,10

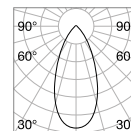

m	lx	øm
1	3740	0,88
2	935	1,76
3	415	2,65
4	233	3,53
5	149	4,42

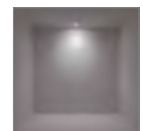

CRI ≥ 82 30W 24° 3150lm 3000K

CRI ≥ 82 30W 36° 3150lm 3000K

CRI ≥ 82 30W 50° 3150lm 3000K



# Fox new

Zylindrischer Strahler aus Aluminium zum Einsatz in 3-Phasen-Schiene geeignet. Pulverlackiert in Weiß, Schwarz oder Messing satiniert; 350° dreh- und 90° schwenkbar; Driver inklusive, im zylindrischen Körper des Strahlers enthalten; erhältlich auch dimmbar in 1-10 V oder DALI; Lichtquelle mit integrierter COB LED Technologie; lieferbar in den Lichtfarben 3000 K und 4000 K und CRI bis zu 90; Binning initial  $\leq 3$ -Step MacAdam; Symmetrische Optik mit Medium-Abstrahlwinkel. Montage und Demontage werkzeuglos; Schutzart IP20; Lebensdauer LED 30.000 h L70B50. Ideal für kleine und mittlere Räume wo nach hoher Flexibilität bei der Verwendung gefragt wird, wo nach guter Flexibilität und Farbwiedergabe gesucht wird, wie z.B. GEW ERBE- und RETAILRÄUME, mit optimalen Preis-/Leistungsverhältnis.

Lichtquelle	LEDCOB
Leistung	8W /15W /25W
Transformator	On/Off /1-10V/DALI
inklusive	
Verfügbare	No
Transformatore	
Schiene	3-Phasen(standard Eutrac)
MacAdam	SDCM3
CCT	3000 K /4000 K
CRI	$\geq 80$ / $\geq 90$
LED Lebensdauer	30.000 h
Schutzklasse	On-Off I, 1-10V/DALI II
IP	20
Material	Aluminium
Garantie	5 Jahre



Link-Seite 650





Hot Drinks		Cold Drinks	
Espresso	1.30 - 2.00	Mineral Water	0.33 l 2.00
Espresso macchiato	1.00 - 2.30	Afri Cola	0.2 l 2.00
Americano	1.00	Seezingle Lemon	0.33 l 2.40
Cappuccino	2.10	... cherry, pear, caramel	
Caffè latte	2.20	Homemade Tamarind-Limonade	0.33 l 3.00
Flat White	2.00	Juice	0.2 l 2.00
Chai Latte	2.00	... apple, raspberry	
Hot Chocolate	2.20	Juice w. sparkling water	0.33 l 2.80
Hot milk w. Honey	2.00	Orange juice	0.2 l 2.00
Latte w. soy-milk		Limonade	0.33 l 2.10
whipped cream		Club Mate	0.33 l 2.20
		Homemade	
		Gingerbeer	0.35 l 3.00
		(no alcohol)	
Acai-Mango-Zinger, Honey-Vanilla-Chamomile, Sleepy-Time, Tension-Tamer, Authentic Green, Black-Cherry-Berry, Apple-Gineman, Chai Bengal Spice			
Fresh Tea	2.50		
Ginger, Mint or Lemax			



# Fox 8W

LED COB BRIDGELUX Transformator inklusive

CRI ≥ 80

Leistung	Beam	Lumen	CCT	Transfor.	Ausführ.	Art.-Nr.	€
8W	41°	1000 lm	3000 K	On-Off	Weiß	250410	49
					Schwarz	250403	49
		1050 lm	4000 K		Weiß	271453	49
					Schwarz	271446	49

CRI ≥ 90

Leistung	Beam	Lumen	CCT	Transfor.	Ausführ.	Art.-Nr.	€
8W	41°	800 lm	3000 K	On-Off	Weiß	285368	49
					Schwarz	285351	49
				1-10V	Weiß	302546	85 <i>new</i>
					Schwarz	302539	85 <i>new</i>

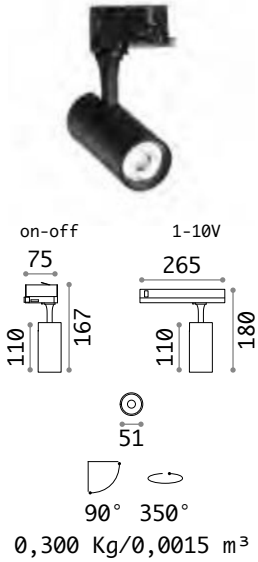

LENS\*

SINGLE CONNECTION

Erforderlich	Beam	Transform.	Ausführ.	Art.-Nr.	€
Nein	15°		Transpar.	302744	5 <i>new</i>
Nein		On/Off	Weiß	170145	27
Nein			Schwarz	170152	27



Light beam: ACCENT

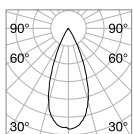

m	lx	Øm
1	2067	0,77
2	517	1,54
3	230	2,30
4	129	3,07
5	83	3,84

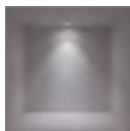

CRI ≥ 80 8W 41° 950lm 3000K

\* Das Objektiv muss zusammen mit dem Produkt bestellt werden und wird anstelle des mitgelieferten Standardobjektivs im Produkt montiert.



# Fox 15W



## LED COB BRIDGELUX Transformator inklusive

### CRI ≥ 80

Leistung	Beam	Lumen	CCT	Transfor.	Ausführ.	Art.-Nr.	€
15W	41°	1700 lm	3000 K	On-Off	Weiß	250434	55
					Schwarz	250427	55
		1750 lm	4000 K	Messing	283937	55 <i>new</i>	
				Weiß	267784	55	
Schwarz	267777	55					

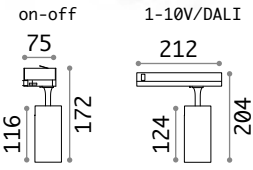

### CRI ≥ 90

Leistung	Beam	Lumen	CCT	Transfor.	Ausführ.	Art.-Nr.	€
15W	41°	1400 lm	3000 K	On-Off	Weiß	285382	55
					Schwarz	285375	55
				1-10V	Weiß	302560	90 <i>new</i>
					Schwarz	302553	90 <i>new</i>
				DALI	Weiß	302584	110 <i>new</i>
					Schwarz	302577	110 <i>new</i>

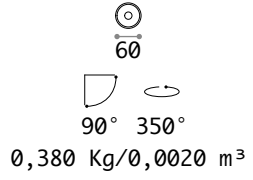

Erforderlich	Beam	Transform.	Ausführ.	Art.-Nr.	€
Nein	15°		Transpar.	302751	5 <i>new</i>
Nein		On/Off	Weiß	170145	27
Nein			Schwarz	170152	27



### LENS\*

### SINGLE CONNECTION



Light beam: ACCENT

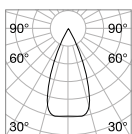

m	lx	Øm
1	3204	0,80
2	801	1,60
3	356	2,40
4	200	3,20
5	128	4,00

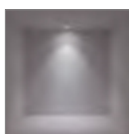

CRI ≥ 80 15W 41° 1500lm 3000K

\* Das Objektiv muss zusammen mit dem Produkt bestellt werden und wird anstelle des mitgelieferten Standardobjektivs im Produkt montiert.



# Fox 25W



## LED COB BRIDGELUX Transformator inklusive

CRI ≥ 80

Leistung	Beam	Lumen	CCT	Transfor.	Ausführ.	Art.-Nr.	€
25 W	35°	2950 lm	3000 K	On-Off	Weiß	250458	60
					Schwarz	250441	60
		3050 lm	4000 K		Messing	283944	60 <i>new</i>
					Weiß	267807	60
					Schwarz	267791	60

CRI ≥ 90

Leistung	Beam	Lumen	CCT	Transfor.	Ausführ.	Art.-Nr.	€
25 W	35°	2450 lm	3000 K	On-Off	Weiß	285405	60
					Schwarz	285399	60
				1-10V	Weiß	302607	100 <i>new</i>
					Schwarz	302591	100 <i>new</i>
				DALI	Weiß	302621	115 <i>new</i>
					Schwarz	302614	115 <i>new</i>

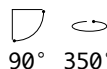
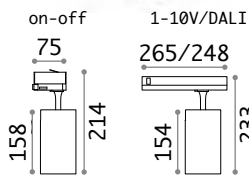

0,540 Kg/0,0027 m<sup>3</sup>

Erforderlich	Beam	Transform.	Ausführ.	Art.-Nr.	€
Nein	15°		Transpar.	302768	5 <i>new</i>
Nein		On/Off	Weiß	170145	27
Nein			Schwarz	170152	27



LENS\*

SINGLE CONNECTION



Light beam: ACCENT

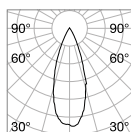

m	lx	cm
1	8140	0,61
2	2035	1,22
3	904	1,82
4	509	2,43
5	326	3,04

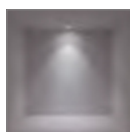

CRI ≥ 80 25W 35° 2500lm 3000K

\* Das Objektiv muss zusammen mit dem Produkt bestellt werden und wird anstelle des mitgelieferten Standardobjektivs im Produkt montiert.



# Eos new

Zylindrischer Strahler aus extrudiertem Aluminium mit symmetrischer Optik und variablem Abstrahlwinkel von eng bis weit (20°–55°), geeignet für die Installation an einer 3-Phasen-Schiene. Pulverbeschichtet in Weiß oder Schwarz, horizontal drehbar bis 355°; vertikal schwenkbar bis 90°; der Treiber für die Stromversorgung ist bereits enthalten und im zylindrischen Körper des Projektors untergebracht. Auch in 1–10V oder DALI dimmbaren Version erhältlich. Lichtquelle mit integrierter COB-LED-Technologie, erhältlich in zwei verschiedenen Wattstärken mit einer Farbtemperatur von 3000K und einem Farbwiedergabeindex  $\geq 90$ ; Binning initial  $\leq 3$  Step MacAdam. Werkzeuglose Montage, Demontage und Einstellung des Abstrahlwinkels. Schutzart IP20; LED-Lebensdauer 30.000 h L70B50. Ideal für die Beleuchtung großer Flächen, die eine hohe Flexibilität und eine hohe Farbwiedergabe erfordern, z. B. Ausstellungsflächen, MUSEEN- und RETAIL-Räume.

Lichtquelle	LEDCOB
Leistung	15W /25W
Transformator	On/Off /1–10V/DALI
inklusive	
Verfügbare	No
Transformatore	
Schiene	3-Phasen(standard Eutrac)
MacAdam	SDCM 3
CCT	3000 K
CRI	$\geq 90$
LED Lebensdauer	30.000 h
Schutzklasse	On-Off I, 1–10V/DALI II
IP	20
Material	Aluminium
Garantie	5 Jahre

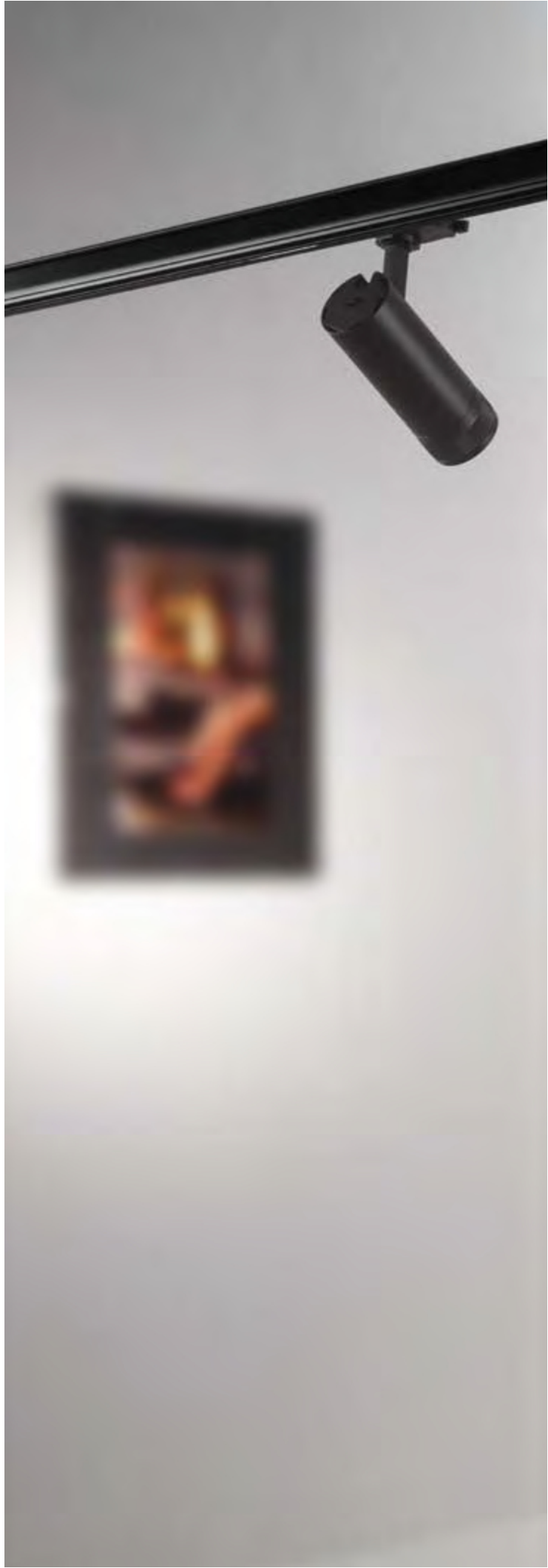

[Link-Seite 650](#)



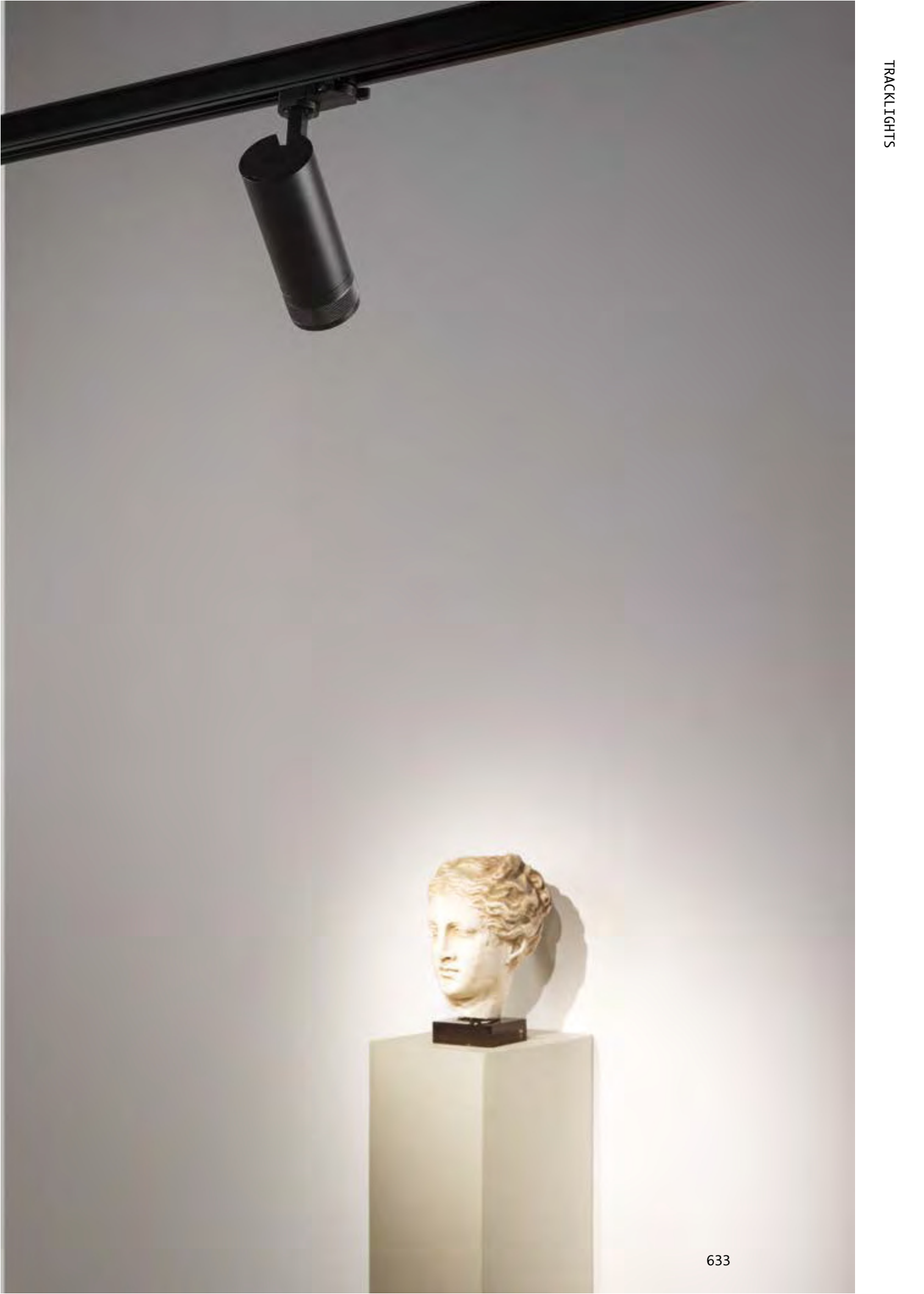



## LED COB BRIDGELUX Transformatorinklusive

Leistung	Beam	Lumen	CCT	Transfor.	Ausführ.	Art.-Nr.	€
14W	20-55°	1550 lm	3000 K	On-Off	Weiß	286594	73
					Schwarz	276182	73
				1-10V	Weiß	302959	116 <small>new</small>
					Schwarz	302942	116 <small>new</small>
				DALI	Weiß	302997	135 <small>new</small>
					Schwarz	302980	135 <small>new</small>

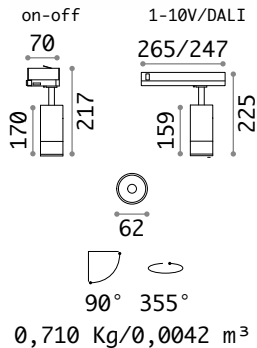

## LED COB BRIDGELUX Transformatorinklusive

Leistung	Beam	Lumen	CCT	Transfor.	Ausführ.	Art.-Nr.	€
25 W	20-55°	3000 lm	3000 K	On-Off	Weiß	286600	92
					Schwarz	276243	92
				1-10V	Weiß	302973	135 <small>new</small>
					Schwarz	302966	135 <small>new</small>
				DALI	Weiß	303017	155 <small>new</small>
					Schwarz	303000	155 <small>new</small>

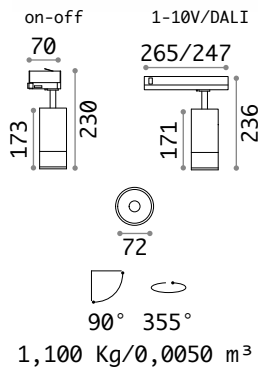

## SINGLE CONNECTION

Erforderlich	Beam	Transform.	Ausführ.	Art.-Nr.	€
Nein		On/Off	Weiß	170145	27
Nein			Schwarz	170152	27



Light beam: from SPOT to WIDE

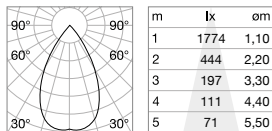

CRI≥90 15W 20-55° 1650lm 3000K

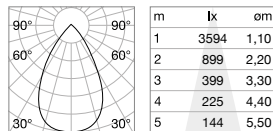

CRI≥90 25W 20-55° 3200lm 3000K





# Pov new



Lichtquelle	LEDCOB	CCT	3000 K
Leistung	22W	CRI	≥95
Transformator	On/Off	LED Lebensdauer	30.000 h
inklusive		Schutzklasse	II
Verfügbare	Nein	IP	20
Transformatore		Material	Aluminium
Schiene	3-Phasen(standard Eutrac)	Garantie	5 Jahre
MacAdam	SDCM 3		

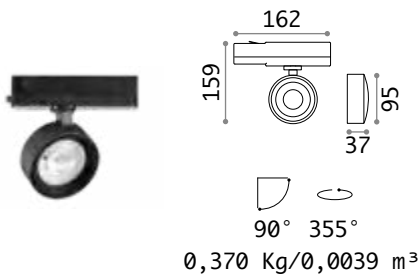

## LEDCOB CREE PHILIPS ON/OFF Transformatorinklusive

Leistung	Beam	Lumen	CCT	Ausführ.	Art.-Nr.	€
22 W	36°	1750lm	3000 K	Weiß	296340	135 <small>new</small>
				Schwarz	296333	135 <small>new</small>

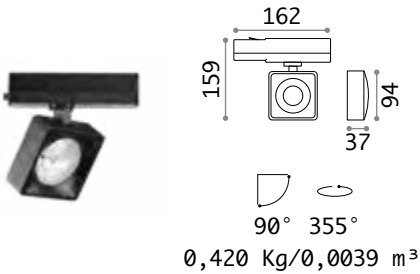

## LEDCOB CREE PHILIPS ON/OFF Transformatorinklusive

Leistung	Beam	Lumen	CCT	Ausführ.	Art.-Nr.	€
22 W	36°	1750lm	3000 K	Weiß	296364	135 <small>new</small>
				Schwarz	296357	135 <small>new</small>



Link-Seite 650



Light beam: ACCENT

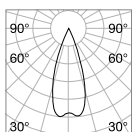

m	lx	øm
1	3646	0,65
2	911	1,30
3	405	1,90
4	228	2,60
5	146	3,20

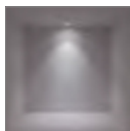

CRI≥95 22W 36° 1750lm 3000K





# Spot – Mouse Track

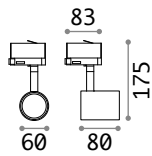

0,250 Kg/0,0016 m<sup>3</sup>

**GU10 Nicht inklusive – Empfohlenes Leuchtmittel** 108292

Leistung	Ausführ.	Art.-Nr.	€
max 50W	Weiß	229706	44
	Schwarz	229720	44
	Messing	269634	44



P. 310 P. 404

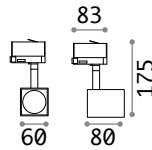

0,300 Kg/0,0027 m<sup>3</sup>

**GU10 Nicht inklusive – Empfohlenes Leuchtmittel** 108292

Leistung	Ausführ.	Art.-Nr.	€
max 50W	Weiß	229768	44
	Schwarz	229782	44



P. 310 P. 404



**SINGLE CONNECTION**

Erforderlich	Transform.	Ausführ.	Art.-Nr.	€
Nein	On/Off	Weiß	170145	27
		Schwarz	170152	27



Link –Seite 650



# Byte new

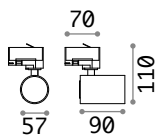

0,200 Kg/0,0013 m<sup>3</sup>

**GU10** Nicht inklusive – Empfohlenes Leuchtmittel 123943



Leistung	Ausführ.	Art.-Nr.	€
max 28W	Weiß	274508	36 <small>new</small>
	Schwarz	274515	36 <small>new</small>



**SINGLE CONNECTION**

Erforderlich	Transform.	Ausführ.	Art.-Nr.	€
Nein	On/Off	Weiß	170145	27
		Schwarz	170152	27



Link-Seite 650



# Glim – König Track new

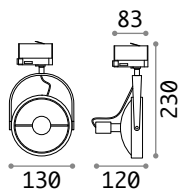

0,320 Kg/0,0180 m<sup>3</sup>

**GU10** Leuchtmittel LED GU10 10W 3000 K inklusive. Art.-Nr. 189031



Leistung	Ausführ.	Art.-Nr.	€
max 50W	Weiß	229676	75
	Schwarz	229683	75



P. 313

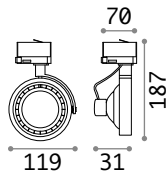

0,330 Kg/0,0035 m<sup>3</sup>

**GU10** Leuchtmittel LED GU10 10W 3000 K inklusive. Art.-Nr. 189031

Leistung	Ausführ.	Art.-Nr.	€
max 50W	Weiß	284880	90 <small>new</small>
	Schwarz	284873	90 <small>new</small>



P. 312



**SINGLE CONNECTION**

Erforderlich	Transform.	Ausführ.	Art.-Nr.	€
Nein	On/Off	Weiß	170145	27
		Schwarz	170152	27



Link-Seite 650





# Look Track

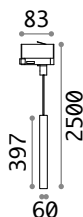

0,930 Kg/0,0037 m<sup>3</sup>

**GU10** Leuchtmittel LED GU10 7W 3000 K inklusive. Art.-Nr. 123943



Leistung	Ausführ.	Art.-Nr.	€
max 28W	Weiß	231662	83
	Schwarz	231631	83



P. 074 P. 298 P. 371



**SINGLE CONNECTION**

Erforderlich	Transform.	Ausführ.	Art.-Nr.	€
Nein	On/Off	Weiß	170145	27
		Schwarz	170152	27



Link-Seite 650

# Display

Linearprojektor aus Aluminium, geeignet für den Einbau in 3-Phasen Profilen (Eutrac-Standard), erhältlich in drei verschiedenen Längen und pulverbeschichtet in weißer oder schwarzer Ausführung. Der Treiber ist bereits in der Schiene untergebracht, um den sichtbaren Platzbedarf des Produkts zu minimieren. Erhältlich in der Ausführung WIDE mit flacher und streuender Optik aus satiniertem PMMA, in der Ausführung UGR mit mikrop Prismatischem PMMA-Lichtverteiler zur Blendungskontrolle und in der Ausführung ACCENT mit schwarzen Reflektoren (UGR <16). Integrierte LED-Quellen; erhältlich in CCT 3000 K und 4000 K; CRI ≥80; LED-Lebensdauer 50.000 h L70B50; werkzeuglose Montage und Demontage. Geeignet für die Beleuchtung von BÜROS, GESCHÄFTSRÄUMEN und AUSSTELLUNGSBEREICHEN, ideal in Kombination mit anderen Stromschiensystemen mit gebündeltem Licht.

**PRO** Hightech-Produkt mit hochwertigen Materialien, gedacht für einen professionellen Einsatz.

**UGR** Artikel mit UGR-Wert <16(Accent), <22(UGR).

Lichtquelle	LED SMD
Leistung	14W /40W
Transformator	On/Off
inklusive	
Verfügbare	No
Transformatoren	
Schiene	3-Phasen(standard Eutrac)
MacAdam	SDCM 3
CCT	3000 K /4000 K
CRI	≥80
UGR	<16(Accent) /<22(UGR)
LED Lebensdauer	50.000 h
Schutzklasse	II
IP	20
Material	Aluminium
Garantie	5 Jahre



Link-Seite 650





# DisplayAccent

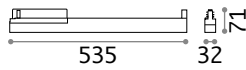

0,400 Kg/0,0064 m<sup>3</sup>

## LED SMD SAMSUNG ON/OFF Transformatorinklusive –UGR <16

Leistung	Beam	Lumen	CCT	Ausführ.	Art.-Nr.	€
14W	60°	1800 lm	3000 K	Weiß	283593	210
				Schwarz	283609	210
		1900 lm	4000 K	Weiß	283616	210
				Schwarz	283623	210

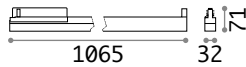

1,120 Kg/0,0112 m<sup>3</sup>

## LED SMD SAMSUNG ON/OFF Transformatorinklusive –UGR <16

Leistung	Beam	Lumen	CCT	Ausführ.	Art.-Nr.	€
28 W	60°	3500 lm	3000 K	Weiß	283524	330
				Schwarz	276267	330
		3700 lm	4000 K	Weiß	283531	330
				Schwarz	283548	330

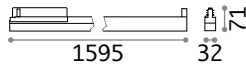

1,570 Kg/0,0173 m<sup>3</sup>

## LED SMD SAMSUNG ON/OFF Transformatorinklusive –UGR <16

Leistung	Beam	Lumen	CCT	Ausführ.	Art.-Nr.	€
40 W	60°	5300 lm	3000 K	Weiß	283555	455
				Schwarz	283562	455
		5600 lm	4000 K	Weiß	283579	455
				Schwarz	283586	455



Light beam: ACCENT

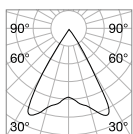

m	lx	øm
1	1330	1,20
2	332	2,40
3	148	3,50
4	83	4,70
5	53	5,90

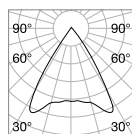

m	lx	øm
1	2453	1,30
2	613	2,50
3	273	3,80
4	153	5,00
5	96	6,30

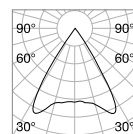

m	lx	øm
1	3598	1,30
2	900	2,50
3	400	3,80
4	225	5,00
5	144	6,30

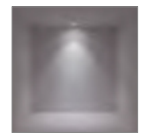

CRI≥80 14W 60° 1800lm 3000K

CRI≥80 28W 60° 3500lm 3000K

CRI≥80 40W 60° 5100lm 3000K



Display Accent 535 mm



Display Accent 1065 mm



Display Accent 1595 mm



# Display Wide

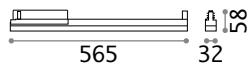

0,420 Kg/0,0067 m<sup>3</sup>

## LED SMD SAMSUNG ON/OFF Transformatorinklusive

Leistung	Beam	Lumen	CCT	Ausführ.	Art-Nr.	€
21W	125°	2800 lm	3000 K	Weiß	283753	175
				Schwarz	283760	175
		2850 lm	4000 K	Weiß	276274	175
				Schwarz	283777	175

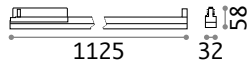

0,770 Kg/0,0124 m<sup>3</sup>

## LED SMD SAMSUNG ON/OFF Transformatorinklusive

Leistung	Beam	Lumen	CCT	Ausführ.	Art-Nr.	€
40 W	125°	5750 lm	3000 K	Weiß	283722	265
				Schwarz	283050	265
		5850 lm	4000 K	Weiß	283739	265
				Schwarz	283746	265



Light beam: WIDE

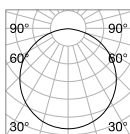

m	lx	øm
1	473	5,20
2	118	6,50
3	53	9,70
4	30	13,00
5	19	16,00

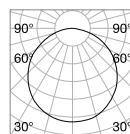

m	lx	øm
1	897	3,10
2	224	6,10
3	100	9,20
4	56	12,00
5	36	15,00



CRI≥80 21W 125° 2400lm 3000K

CRI≥80 40W 125° 4300lm 3000K



Display Wide 565 mm



Display Wide 1125 mm



# Display UGR

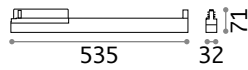

0,400 Kg/0,0064 m<sup>3</sup>

## LED SMD SAMSUNG ON/OFF Transformatorinklusive –UGR <22

Leistung	Beam	Lumen	CCT	Ausführ.	Art.-Nr.	€
14W	70°	2000 lm	3000 K	Weiß	283685	185
				Schwarz	283692	185
		2100 lm	4000 K	Weiß	283708	185
				Schwarz	283715	185

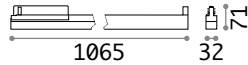

1,120 Kg/0,0112 m<sup>3</sup>

## LED SMD SAMSUNG ON/OFF Transformatorinklusive –UGR <22

Leistung	Beam	Lumen	CCT	Ausführ.	Art.-Nr.	€
27W	70°	4000 lm	3000 K	Weiß	283647	290
				Schwarz	283630	290
		4300 lm	4000 K	Weiß	276281	290
				Schwarz	283258	290

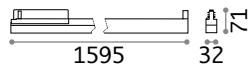

1,570 Kg/0,0173 m<sup>3</sup>

## LED SMD SAMSUNG ON/OFF Transformatorinklusive –UGR <22

Leistung	Beam	Lumen	CCT	Ausführ.	Art.-Nr.	€
40W	70°	6050 lm	3000 K	Weiß	283654	410
				Schwarz	283067	410
		6450 lm	4000 K	Weiß	283661	410
				Schwarz	283678	410



Light beam: WIDE

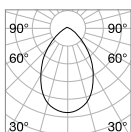

m	lx	øm
1	854	1,40
2	213	2,80
3	95	4,20
4	53	5,70
5	34	7,10

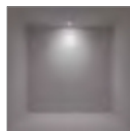

CRI≥80 14W 70° 1600lm 3000K

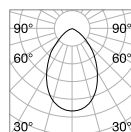

m	lx	øm
1	1636	1,40
2	409	2,80
3	182	4,20
4	102	5,70
5	65	7,10

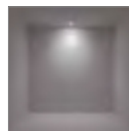

CRI≥80 27W 70° 3100lm 3000K

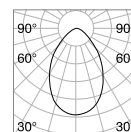

m	lx	øm
1	2419	1,40
2	605	2,80
3	269	4,20
4	151	5,70
5	97	7,10

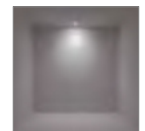

CRI≥80 40W 70° 4500lm 3000K



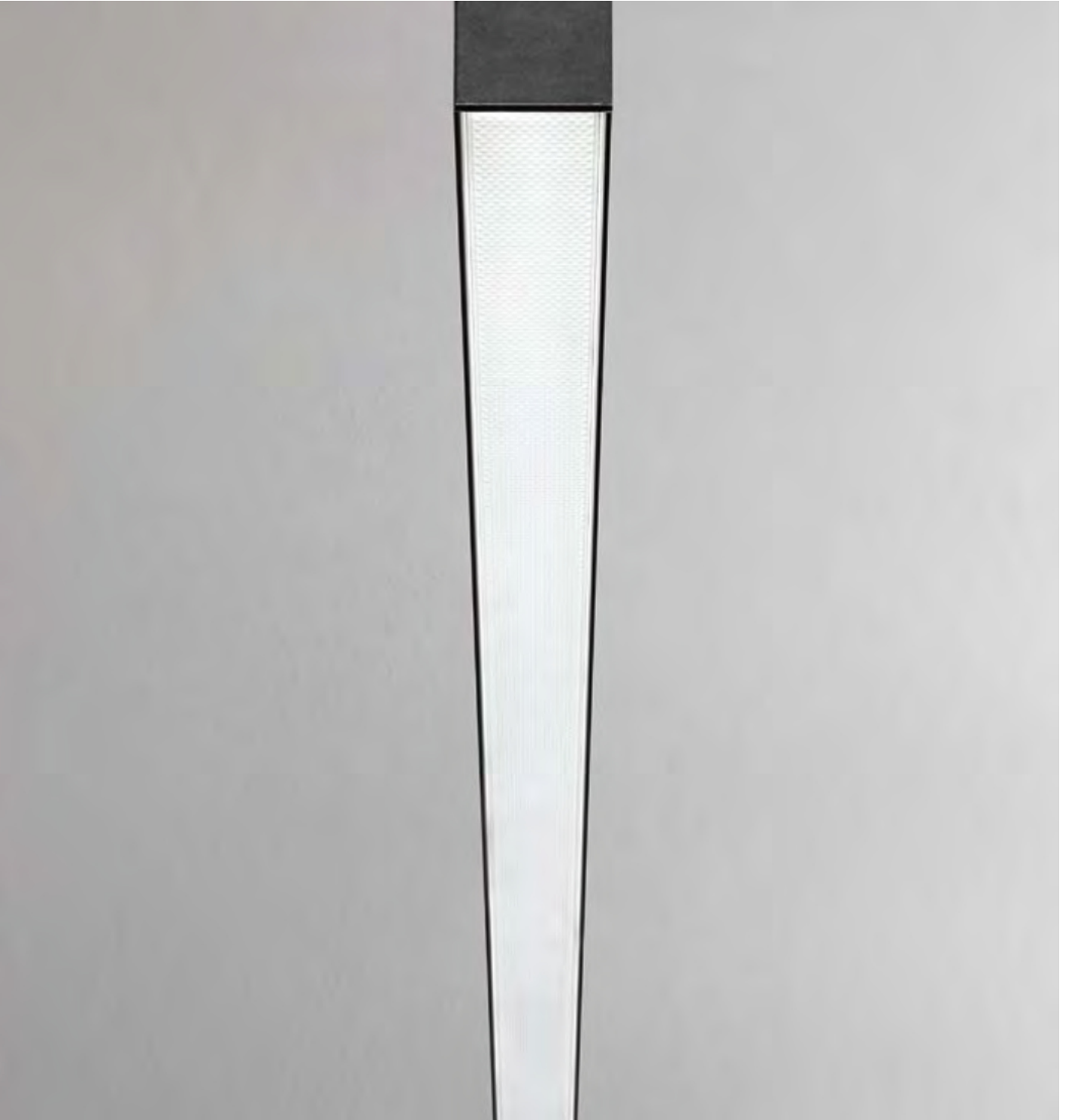

Display UGR 535 mm



Display UGR 1065 mm



Display UGR 1595 mm



# Link

Profil aus extrudiertem Aluminium zum Einsatz in 3-Phasen-Schiene; weiß oder schwarz pulverlackiert, optimiert für Eutrac-Standard Strahler; erhältlich für die Decke, Hängemontage oder randlosen Einbau in Gipskartondecken; geeignet für Liniensysteme, Standard-Module in den Längen 2000 mm oder 3000 mm. Ideal für große Räume, wonach guter Flexibilität, wie z.B. MUSEUMS-, GEW ERBE- und RETAILRÄUME. 5 Jahre Garantie.





# Link Trimless On/Off

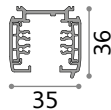
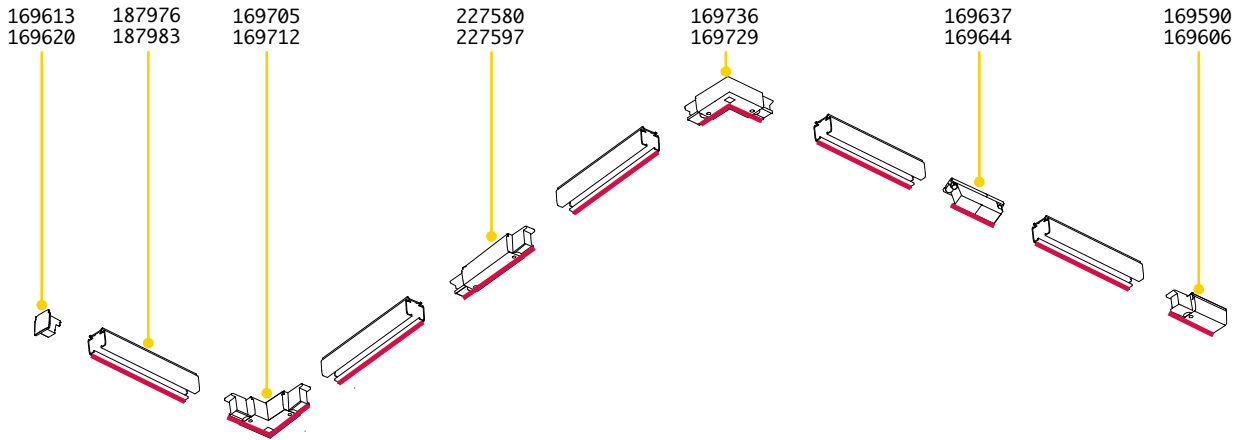

## TRACK

Länge	Gewicht	Volumen	Ausführ.	Art.-Nr.	€
1000 mm	0,94Kg	0,0016 m <sup>3</sup>	Weiß	243269	33
			Schwarz	243252	33
2000 mm	1,93Kg	0,0032 m <sup>3</sup>	Weiß	187976	64
			Schwarz	187983	64
3000 mm	2,87Kg	0,0048 m <sup>3</sup>	Weiß	187990	100
			Schwarz	188003	100



## KITSURFACE

Erforderlich	Kabelanz.	Kabellänge	Ausführ.	Art.-Nr.	€
Ja -1Kit x 1000mm			Weiß	169972	7
			Schwarz	169989	7



## SUSPENSION KIT

Erforderlich	Kabelanz.	Kabellänge	Ausführ.	Art.-Nr.	€
Ja -1Kit x 1000mm	1	3000 mm	Weiß	242705	16
			Schwarz	243283	16
	1	5000 mm	Weiß	243245	18
			Schwarz	243238	18



## MAIN CONNECTOR END

0,060 Kg/0,0002 m<sup>3</sup>

169583	L	€ 16
169576	L	€ 16
169590	R	€ 16
169606	R	€ 16

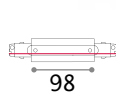

## MAIN CONNECTOR MIDDLE

0,120 Kg/0,0004 m<sup>3</sup>

227580	€ 25
227597	€ 25

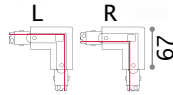

## MAIN CONNECTOR CORNER

0,110 Kg/0,0005 m<sup>3</sup>

169705	L	€ 25
169712	L	€ 25
169736	R	€ 25
169729	R	€ 25

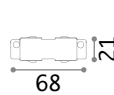

## ELECTRIFIED CONNECTOR

0,030 Kg/0,0001 m<sup>3</sup>

169637	€ 8
169644	€ 8



## END CAP

0,010 Kg/0,0001 m<sup>3</sup>

169613	€ 4
169620	€ 4

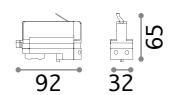

## TRACK ADAPTOR

0,080 Kg/0,0002 m<sup>3</sup>

194257	€ 12
194301	€ 12

# Link Trimless DALI – 1–10V

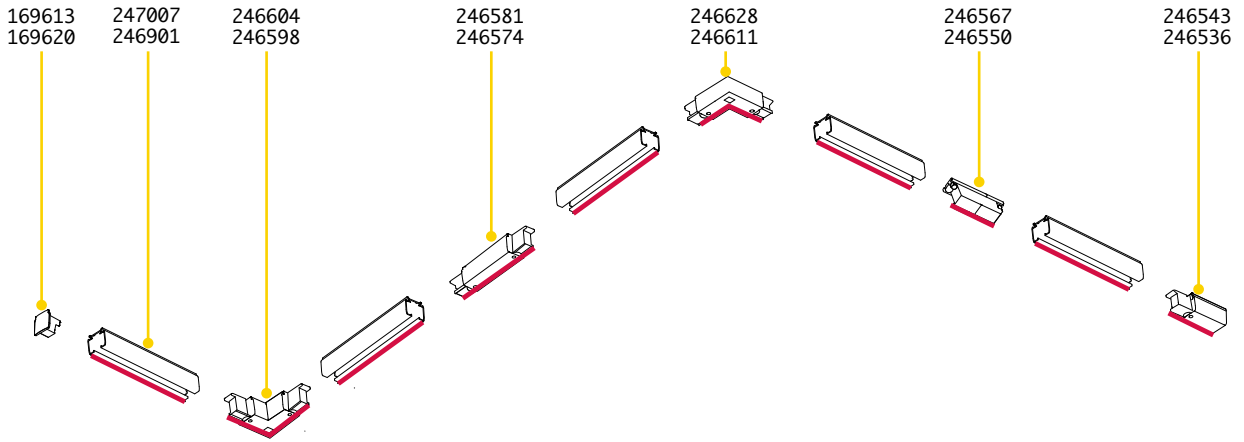

## TRACK

Länge	Gewicht	Volumen	Ausführ.	Art.-Nr.	€
1000 mm	0,94 Kg	0,0016 m <sup>3</sup>	Weiß	246468	37
			Schwarz	246451	37
2000 mm	1,93 Kg	0,0032 m <sup>3</sup>	Weiß	247007	70
			Schwarz	246901	70
3000 mm	2,87 Kg	0,0048 m <sup>3</sup>	Weiß	247625	103
			Schwarz	247618	103



## KIT SURFACE



## KIT SUSPENSION

Erforderlich	Kabelanz.	Kabellänge	Ausführ.	Art.-Nr.	€
Ja -1Kit x 1000mm			Weiß	169972	7
			Schwarz	169989	7
Ja -1Kit x 1000mm	1	3000 mm	Weiß	242705	16
			Schwarz	243283	16
	1	5000 mm	Weiß	243245	18
			Schwarz	243238	18

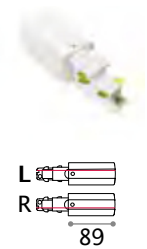

## MAIN CONNECTOR END

0,079 Kg/0,0002 m<sup>3</sup>

246529	L	€ 17
246512	R	€ 17
246543	R	€ 17
246536	R	€ 17



## MAIN CONNECTOR MIDDLE

0,129 Kg/0,0004 m<sup>3</sup>

246581	€ 28
246574	€ 28

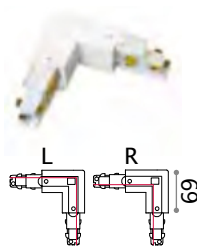

## MAIN CONNECTOR CORNER

0,130 Kg/0,0006 m<sup>3</sup>

246604	L	€ 29
246598	R	€ 29
246628	R	€ 29
246611	R	€ 29



## ELECTRIFIED CONNECTOR

0,041 Kg/0,0001 m<sup>3</sup>

246567	€ 12
246550	€ 12



## END CAP

0,010 Kg/0,0001 m<sup>3</sup>

169613	€ 4
169620	€ 4

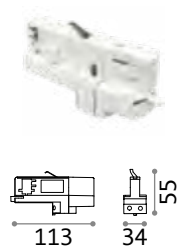

## TRACK ADAPTOR

0,063 Kg/0,0003 m<sup>3</sup>

246505	€ 20
246499	€ 20

# Link Trim On/Off

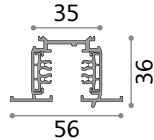
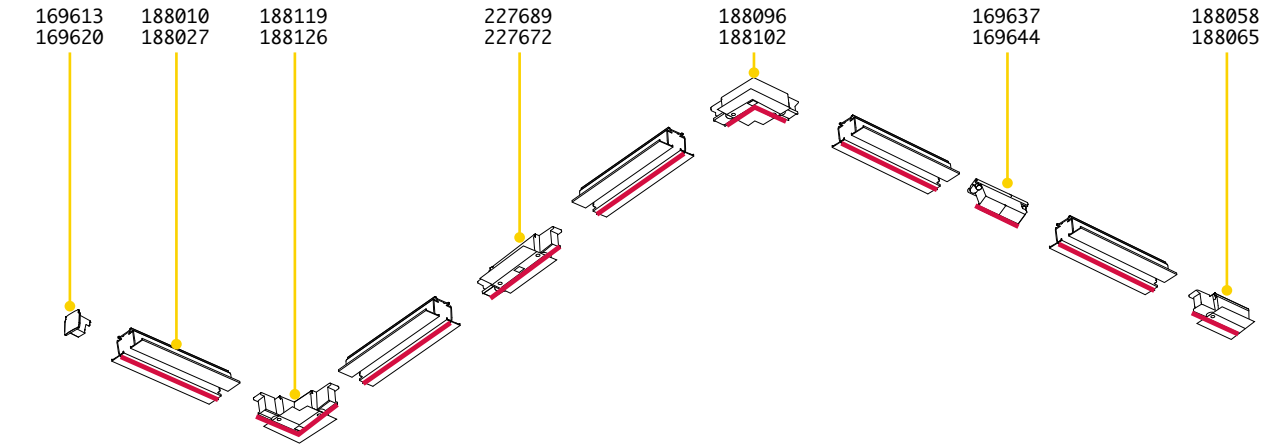





## TRACK

Länge	Gewicht	Volumen	Ausführ.	Art.-Nr.	€
2000 mm	2,1Kg	0,0048 m <sup>3</sup>	Weiß	188010	68
			Schwarz	188027	68

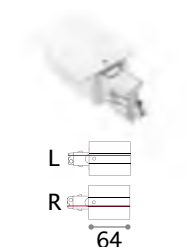

## KITRECESSED

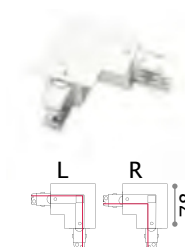
Erforderlich	Art.-Nr.	€
Ja -1Kt x 1000mm	188195	6

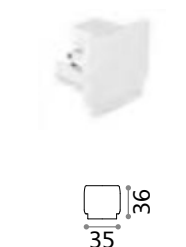
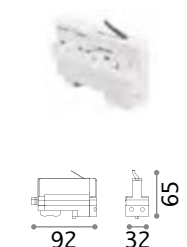
					
<b>MAIN CONNECTOR END</b>	<b>MAIN CONNECTOR MIDDLE</b>	<b>MAIN CONNECTOR CORNER</b>	<b>ELECTRIFIED CONNECTOR</b>	<b>END CAP</b>	<b>TRACK ADAPTOR</b>
0,070 Kg/0,0002 m <sup>3</sup>	0,130 Kg/0,0004 m <sup>3</sup>	0,120 Kg/0,0006 m <sup>3</sup>	0,030 Kg/0,0001 m <sup>3</sup>	0,010 Kg/0,0001 m <sup>3</sup>	0,080 Kg/0,0002 m <sup>3</sup>
188072 L € 18	188089 L € 18	188119 L € 28	188096 L € 28	169613 € 4	194257 € 12
188058 R € 18	227689 € 29	188126 L € 28	188096 R € 28	169620 € 4	194301 € 12
188065 R € 18	227672 € 29	188102 R € 28	169644 € 8		

# Link Trim DALI - 1-10V

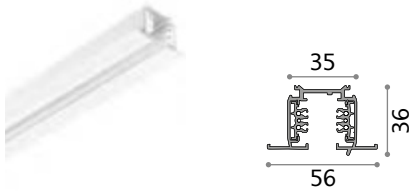
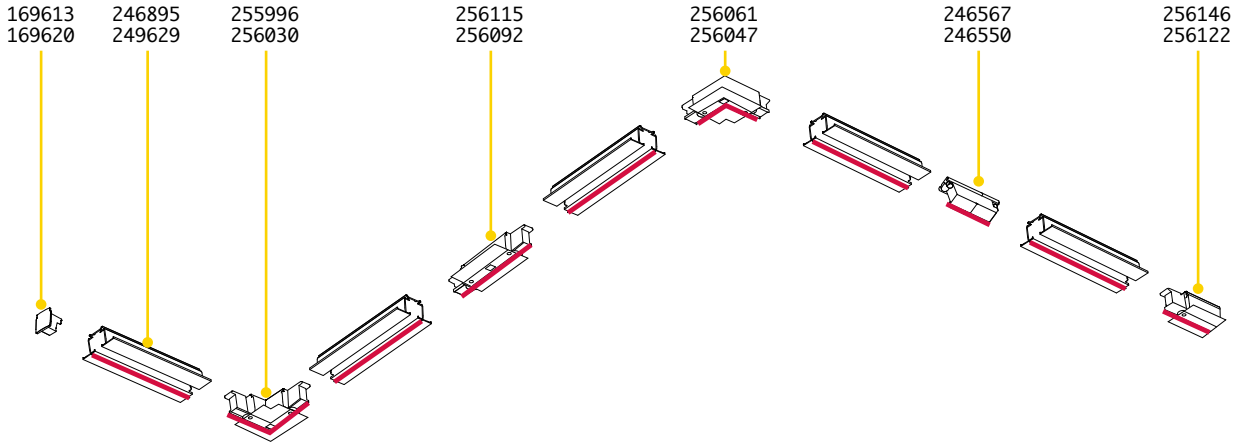

## TRACK

Länge	Gewicht	Volumen	Ausführ.	Art-Nr.	€
2000 mm	2,11Kg	0,0048 m <sup>3</sup>	Weiß	246895	76
			Schwarz	249629	76



Erforderlich	Art-Nr.	€
Ja -1Kit x 1000mm	188195	6

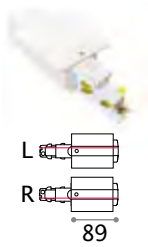

MAIN CONNECTOR END

0,089 Kg/0,0004 m<sup>3</sup>

- 256085 L € 19
- 256078 R € 19
- 256146 L € 19
- 256122 R € 19



MAIN CONNECTOR MIDDLE

0,145 Kg/0,0005 m<sup>3</sup>

- 256115 L € 31
- 256092 R € 31

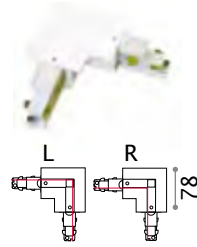

MAIN CONNECTOR CORNER

0,143 Kg/0,0006 m<sup>3</sup>

- 256030 L € 31
- 255996 R € 31
- 256061 L € 31
- 256047 R € 31

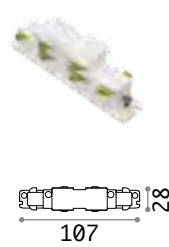

ELECTRIFIED CONNECTOR

0,041 Kg/0,0001 m<sup>3</sup>

- 246567 L € 12
- 246550 R € 12



END CAP

0,010 Kg/0,0001 m<sup>3</sup>

- 169613 L € 4
- 169620 R € 4

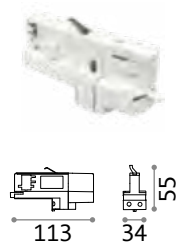

TRACK ADAPTOR

0,063 Kg/0,0003 m<sup>3</sup>

- 246505 L € 20
- 246499 R € 20

































# Innenräume

## Einbauleuchte

### Alphabetisches inhalt

Basic	688
Bento	658
Blues	716
Channel	699
Deep	686
Dynamic	664
Eye	710
Funky	714
Galileo	710
Game	672
Groove	694
Jazz	714
Led Panel	702
Lika	704
Lounge	714
Nova	700
Off	682
One	678
Play	698
Polka	718
Quark	681
Room-65	715
Samba	712
Soul	717
Swing	714
Virus	680
Walky	719
Zephyr	711

### Inhalt Typen

				
Bento 658	Dynamic 664	Game 672	One 678	Virus 680
				
Quark 681	Off 682	Deep 686	Basic 688	Groove 694
				
Play 698	Channel 699	Nova 700	Led Panel 702	Lika 704
				
Galileo 710	Eye 710	Zephyr 711	Samba 712	Jazz 714
				
Swing 714	Lounge 714	Funky 714	Room-65 715	Blues 716
				
Soul 717	Soul 717	Polka 718	Walky 719	

# Bento

Modulares System von Einbauelementen, bestehend aus schwenkbarer Lichtquelle, Reflektor und Schraubring, mit optionalen Linsen und Abschirmungszubehör; weiße und schwarze Ausführung; Einbau-Schraubring erhältlich in einfacher runder oder quadratischer Form oder rechteckig in doppelter oder dreifacher Ausführung für die Installation mehrerer, unabhängiger Lichtquellen; optionaler Abblendschutzring zum Einfahren der Lichtquelle im nicht schwenkbaren Modus; drei verschiedene Abstrahlwinkel zur Auswahl. Lichtquelle mit integrierter COB-LED-Technologie für höchste Effizienz, erhältlich mit 3000 K Farbtemperatur; energieeffiziente LED mit hoher Farbwiedergabe; CRI  $\geq 90$ ; Initial Binning  $\leq 3$ -Step MacAdam; Isolationsklasse II; LED-Lebensdauer 50.000 h L70B50. Erhältlich in den Versionen DALI und 1-10V dimmbar. Dank seiner kompakten Größe und großen Vielseitigkeit ist er ideal für Inneninstallationen in HÄUSERN, BÜROS und VERKAUFSFLÄCHEN.

**PRO** Hightech-Produkt mit hochwertigen Materialien, gedacht für einen professionellen Einsatz.

**UGR** Artikel mit UGR-Wert  $< 19$ .

Lichtquelle	LEDCOB
Leistung	9W /13W
Transformator	On/Off
inklusive	
Verfügbare	1-10V/DALI /Push
Transformatore	
MacAdam	SDCM 3
CCT	3000 K
CRI	$\geq 90$
UGR	$< 19$
LED Lebensdauer	50.000 h
Schutzklasse	II
IP	20
Material	Aluminium
Garantie	5 Jahre





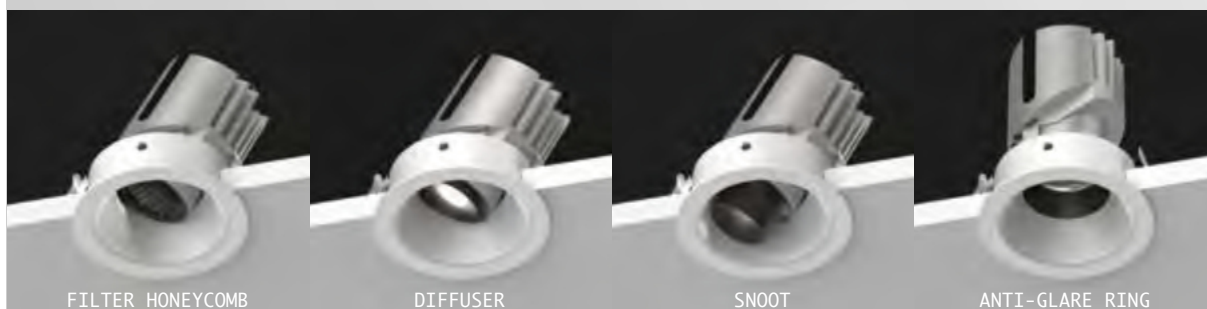
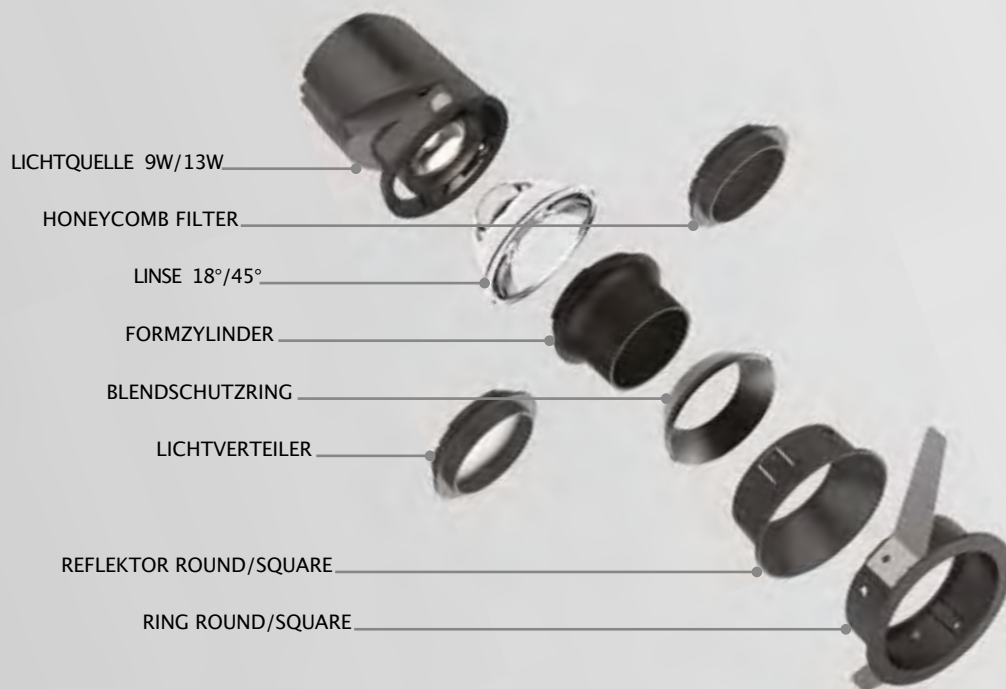

	Erforderlich	Beam	Ausführ.	Art.-Nr.	€
	Nein	18°	Transpar.	287942	4
		45°	Transpar.	279626	4
	Nein		Schwarz	279718	4
	Nein		Schwarz	279725	3
	Nein		Schwarz	279701	4
	Nein		Weiß	288147	3
			Schwarz	279695	3

# Bento – Source

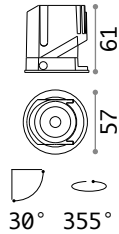
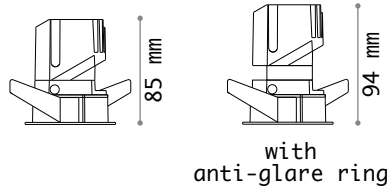

0,180 Kg/0,0003 m<sup>3</sup>

**LED COB CITIZEN** Erforderlich –TRIDONIC ON/OFF Transfor.inklusive

Leistung	Beam	Lumen	CCT	Ausführ.	Art.-Nr.	€
9W	36°	730 lm	3000 K	Schwarz	279596	45

**DIMMABLE DRIVER\*** Optionals

	Leistung	Output	Maß (LxH xB)	Art.-Nr.	€
1-10V	12W	250 mA	122x25 x 40 mm	287843	58
DALI /Push	20 W	250 mA	120x29 x 51mm	287850	87

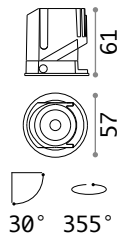

0,200 Kg/0,0003 m<sup>3</sup>

**LED COB CITIZEN** Erforderlich –TRIDONIC ON/OFF Transfor.inklusive

Leistung	Beam	Lumen	CCT	Ausführ.	Art.-Nr.	€
13W	36°	1000 lm	3000 K	Schwarz	279602	50

**DIMMABLE DRIVER\*** Optionals

	Leistung	Output	Maß (LxH xB)	Art.-Nr.	€
1-10V/Push	20 W	350 mA	108x22 x 52 mm	287867	75
DALI /Push	20 W	350 mA	120x29 x 51mm	287874	80



Light beam: ACCENT

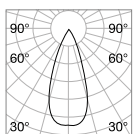

m	lx	øm
1	1312	0,71
2	328	1,40
3	146	2,10
4	82	2,80
5	52	3,50

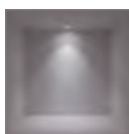

CRI≥90 9W 36° 850lm 3000K

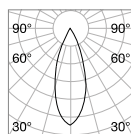

m	lx	øm
1	1846	0,65
2	461	1,30
3	205	1,90
4	115	2,60
5	74	3,20



CRI≥90 13W 36° 1100lm 3000K

\* Dimmbare Treiber müssen mit dem Artikel mitbestellt werden und werden bei dem Produkt anstelle der on-off Treiber eingebaut. \*\* Objektiv 36° inklusive.

# Bento – Frame and Reflector

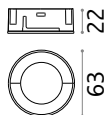

## ROUND – REFLECTOR Erforderlich

Ausführ.	Art.-Nr.	€
Weiß	279633	6
Schwarz	279640	6

0,020 Kg/0,0001 m<sup>3</sup>

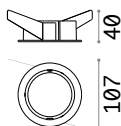

## ROUND – FRAME SINGLE Erforderlich

Ausführ.	Art.-Nr.	€
Weiß	287898	12
Schwarz	287881	12

Ⓜ 68 mm

0,060 Kg/0,0007 m<sup>3</sup>

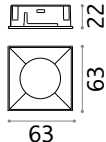

## SQUARE – REFLECTOR Erforderlich

Ausführ.	Art.-Nr.	€
Weiß	279671	8
Schwarz	279688	8

0,020 Kg/0,0001 m<sup>3</sup>

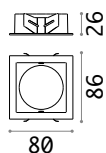

## SQUARE – FRAME SINGLE Erforderlich

Ausführ.	Art.-Nr.	€
Weiß	287911	14
Schwarz	287904	14

Ⓜ 68 x 68 mm

0,050 Kg/0,0002 m<sup>3</sup>

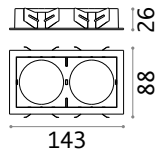

## SQUARE – FRAME TWIN Erforderlich

Ausführ.	Art.-Nr.	€
Weiß	287935	24
Schwarz	280233	24

Ⓜ 134 x 71 mm

0,110 Kg/0,0004 m<sup>3</sup>

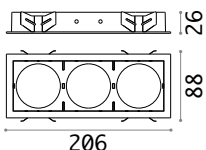

## SQUARE – FRAME TRIPLE Erforderlich

Ausführ.	Art.-Nr.	€
Weiß	287928	30
Schwarz	280240	30

Ⓜ 197 x 71 mm

0,300 Kg/0,0006 m<sup>3</sup>

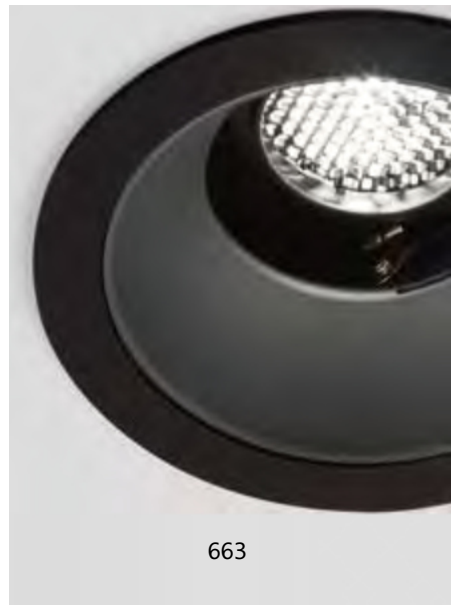

# Dynamic

Kombinierbares System mit Einbauelementen aus Aluminium bestehend aus Lichtquelle, Reflektor und Ring; Linsen und Scheiben optional; Ausführung weiß, chrom, schwarz, gold; Einbau rund oder quadratisch möglich; Reflektor symmetrisch oder asymmetrisch; drei verschiedene Ausstrahlwinkel, je nach Wahl. Lichtquelle mit COB LED Technologie für höchste Effizienz. Lieferbar in den Lichtfarben 2700K, 3000 K oder 4000 K; energieeffiziente LED mit sehr guter Farbwiedergabe; CRI  $\geq 90$ ; Binning initial  $\leq 3$ -Step MacAdam; frontaler Schutz IP54 (nach beendeter Installation); Schutzklasse II; Lebensdauer LED 50.000 h L70B50.1-10V dimmbar oder DALI-dimmbar. Kompakt und vielseitig, ist der Artikel optimal für Innenräume in HAUS, BÜRO und RETAIL.

**PRO** Hightech-Produkt mit hochwertigen Materialien, gedacht für einen professionellen Einsatz.

**UGR** Artikel mit UGR-Wert  $< 19$ .

**IP54** Schutzart IP54.

Lichtquelle	LEDCOB
Leistung	9W /10W /15W
Transformator	On/Off
inklusive	
Verfügbare	1-10V/DALI /Push
Transformatore	
MacAdam	SDCM 3
CCT	2700 K /3000 K /4000 K
CRI	$\geq 90$
UGR	$< 19$
LED Lebensdauer	50.000 h
Schutzklasse	II
IP	54
Material	Aluminium
Garantie	5 Jahre







**LENS**



**FILTER HONEYCOMB**



**FILTER ELLIPTICAL**



**GU10 ADAPTOR WITH LAMP HOLDER INCLUDED -IP20**

Erforderlich	Beam	Ausführ.	Art.-Nr.	€
Nein	20°	Transpar.	211763	7
	55°	Transpar.	211770	7
Nein		Schwarz	208671	7
Nein		Transpar.	208688	7
Nein		Weiß	208640	16
		Schwarz	208657	16



Light beam: ACCENT

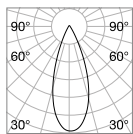

m	lx	øm
1	1653	0,72
2	413	1,44
3	184	2,16
4	103	2,88
5	66	3,60

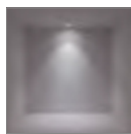

CRI≥90 9W 35° 1000lm 3000K

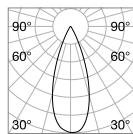

m	lx	øm
1	1643	0,66
2	410	1,32
3	182	1,98
4	102	2,64
5	65	3,30



CRI≥90 10W 35° 1250lm 3000K

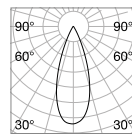

m	lx	øm
1	2294	0,64
2	573	1,29
3	254	1,93
4	143	2,58
5	91	3,23

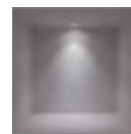

CRI≥90 15W 35° 1600lm 3000K

# Dynamic – Source

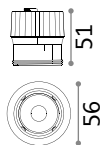

0,180 Kg/0,0030 m<sup>3</sup>

## LED COB CITIZEN Erforderlich –TRIDONIC ON/OFF Transfor.inklusive

Leistung	Beam	Lumen	CCT	Ausführ.	Art.-Nr.	€
9W	35°	840 lm	2700 K	Schwarz	252971	45
		870 lm	3000 K	Schwarz	252988	45
		1000 lm	4000 K	Schwarz	252995	45

## DIMMABLE DRIVER\* Optionals

	Leistung	Output	Maß (LxH xB)	Art.-Nr.	€
1-10V	12W	200 mA	125x27x45 mm	253008	45
DALI	20 W	200 mA	135x20x30 mm	253015	65

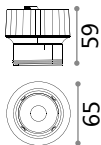

0,150 Kg/0,0030 m<sup>3</sup>

## LED COB CITIZEN Erforderlich –TRIDONIC ON/OFF Transfor.inklusive

Leistung	Beam	Lumen	CCT	Ausführ.	Art.-Nr.	€
10W	35°	970 lm	2700 K	Schwarz	208541	65
		1000 lm	3000 K	Schwarz	208558	65
		1100lm	4000 K	Schwarz	208565	65

## DIMMABLE DRIVER\* Optionals

	Leistung	Output	Maß (LxH xB)	Art.-Nr.	€
1-10V	10W	250 mA	135x20x30 mm	216317	25
DALI/Push	17W	250 mA	130x30x43 mm	216027	110

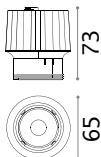

0,200 Kg/0,0030 m<sup>3</sup>

## LED COB CITIZEN Erforderlich –TRIDONIC ON/OFF Transfor.inklusive

Leistung	Beam	Lumen	CCT	Ausführ.	Art.-Nr.	€
15W	35°	1500 lm	2700 K	Schwarz	208572	90
		1150lm	3000 K	Schwarz	208589	90
		1650 lm	4000 K	Schwarz	208596	90

## DIMMABLE DRIVER\* Optionals

	Leistung	Output	Maß (LxH xB)	Art.-Nr.	€
1-10V	20 W	350 mA	101x29x51mm	216324	50
DALI/Push	17W	350 mA	130x30x43 mm	216263	115

\* Dimmbare Treiber müssen mit dem Artikel mitbestellt werden und werden bei dem Produkt anstelle der on-off Treiber eingebaut. \*\* Objektiv 35° inklusive.

# Dynamic Round

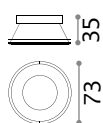
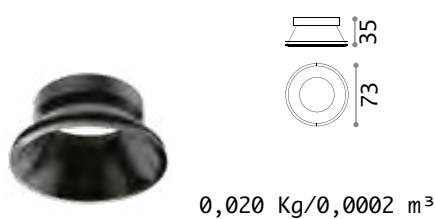
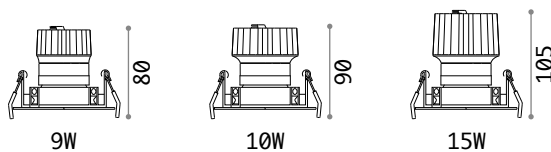

**REFLECTOR** Erforderlich

SYMMETRISCH

Ausführ.	Art.-Nr.	€
Weiß	211787	8
Chrom	221649	8
Schwarz	211794	8
Gold	211800	8

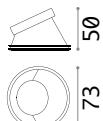

ASYMMETRISCH -30°

Ausführ.	Art.-Nr.	€
Weiß	211848	8
Chrom	221663	8
Schwarz	211855	8
Gold	211862	8

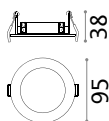
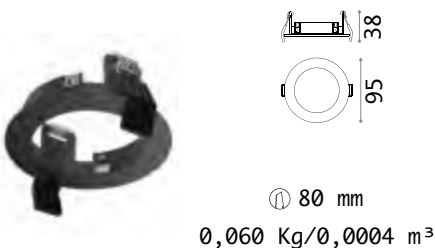

**FRAME** Erforderlich

Ausführ.	Art.-Nr.	€
Weiß	208695	17
Chrom	221687	17
Schwarz	208701	17
Gold	208718	17

⌀ 80 mm



# Dynamic Square

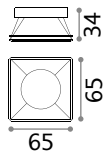
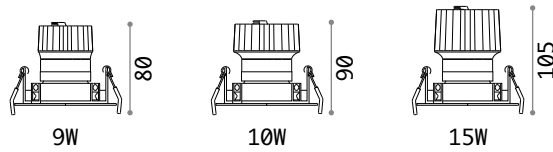

0,020 Kg/0,0002 m<sup>3</sup>

## REFLECTOR Erforderlich

### SYMMETRISCH

Ausführ.	Art-Nr.	€
Weiß	211817	8
Chrom	221656	8
Schwarz	211824	8
Gold	211831	8

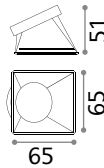

0,020 Kg/0,0002 m<sup>3</sup>

## ASYMMETRISCH -30°

Ausführ.	Art-Nr.	€
Weiß	211879	8
Chrom	221670	8
Schwarz	211886	8
Gold	211893	8

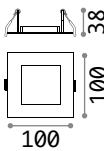

Ⓜ 90 mm  
0,050 Kg/0,0004 m<sup>3</sup>

## FRAME Erforderlich

Ausführ.	Art-Nr.	€
Weiß	208725	19
Chrom	221694	19
Schwarz	208732	19
Gold	208749	19

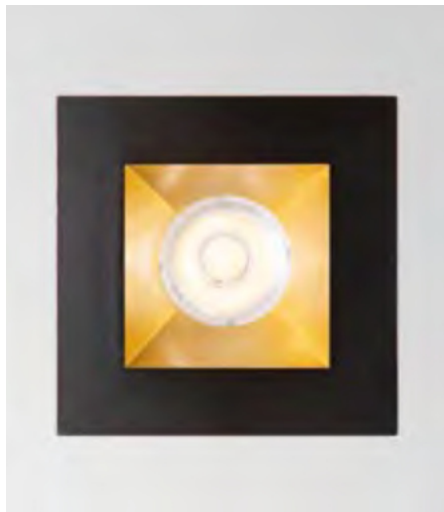

# Game

Einbaustrahler aus Aluminiumspritzguss mit rundem oder quadratischem Ring, für Einbau in Gipskartondecken geeignet. Ausführung chrom matt, weiß matt RAL 9001, schwarz matt RAL 9011, gold matt RAL 1032. Technologie für höchste Effizienz; Lieferbar in der Lichtfarbe 2700K, 3000 K oder 4000 K. Montage und Demontage werkzeuglos; Schutzart IP20; Schutzklasse II; Lebensdauer LED 50.000h L70B50.1-10V dimmbar oder DALI-dimmbar optional.

**UGR** Artikel mit UGR-Wert <19.

Lichtquelle	LEDCOB
Leistung	11W/20W
Transformator	On/Off
inklusive	
Verfügbare	1-10V/DALI
Transformatore	
CCT	2700 K /3000 K /4000 K
CRI	≥80 /≥90
UGR	<19
LED Lebensdauer	50.000 h
Schutzklasse	II
IP	20
Material	Aluminium
Garantie	5 Jahre







# Game Round

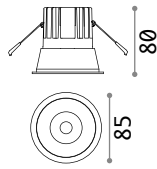

⌀ 74 mm  
0,280 Kg/0,0011 m<sup>3</sup>

## LEDCOB CREE ON/OFF Transformatorinklusive –CRI ≥80

Leistung	Beam	Lumen	CCT	Ausführ.	Art.-Nr.	€
11W	36°	1000lm	2700 K	Weiß +	285429	47
		1100lm	3000 K	Silber +	192284	47
				Weiß +	192291	47
				Schwarz +	192277	47
				Gold +	192307	47
	1250lm	4000 K	Weiß +	267975	47	

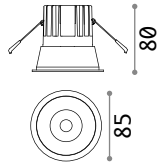

⌀ 74 mm  
0,280 Kg/0,0011 m<sup>3</sup>

## LEDCOB CREE ON/OFF Transformatorinklusive –CRI ≥80

Leistung	Beam	Lumen	CCT	Ausführ.	Art.-Nr.	€
11W	36°	1000lm	2700 K	Schwarz +	285412	47
		1100lm	3000 K	Silber +	192321	47
				Weiß +	192338	47
				Schwarz +	192314	47
				Gold +	192345	47
	1250lm	4000 K	Schwarz +	267968	47	

## DIMMABLE DRIVER\* Optionals

	Leistung	Output	Maß (LxH xB)	Art.-Nr.	€
1-10V	12W	250 mA	150x29x43 mm	217253	40
DALI	11W	250 mA	135x20x30 mm	202396	60

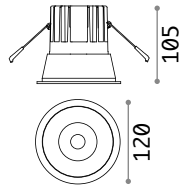

⌀ 110 mm  
0,660 Kg/0,0033 m<sup>3</sup>

## LEDCOB BRIDGELUX ON/OFF Transformatorinklusive –CRI ≥90

Leistung	Beam	Lumen	CCT	Ausführ.	Art.-Nr.	€
20W	24°	2350lm	3000 K	Weiß +	273174	90
				Schwarz +	273167	90



Light beam: ACCENT



Light beam: SPOT

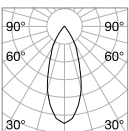

m	lx	øm
1	1545	0,69
2	386	1,38
3	171	2,07
4	96	2,77
5	61	3,46



CRI≥90 11W 36° 850lm 3000K

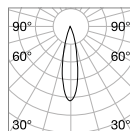

m	lx	øm
1	8645	0,41
2	2161	0,83
3	961	1,20
4	540	1,70
5	346	2,10



CRI≥90 20W 24° 1850lm 3000K

\* Dimmbare Treiber müssen mit dem Artikel mitbestellt werden und werden bei dem Produkt anstelle der on-off Treiber eingebaut.



# Game Square

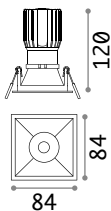

75 x 75 mm  
0,270 Kg/0,0011 m<sup>3</sup>

## LEDCOB CREE ON/OFF Transformatorinklusive –CRI ≥80

Leistung	Beam	Lumen	CCT	Ausführ.	Art.-Nr.	€
11W	36°	1000lm	2700 K	Weiß +	285443	47
		1100lm	3000 K	Weiß +	192376	47
				Schwarz +	192352	47

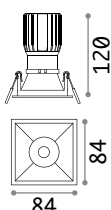

75 x 75 mm  
0,270 Kg/0,0011 m<sup>3</sup>

## LEDCOB CREE ON/OFF Transformatorinklusive –CRI ≥80

Leistung	Beam	Lumen	CCT	Ausführ.	Art.-Nr.	€
11W	36°	1000lm	2700 K	Schwarz +	285436	47
		1100lm	3000 K	Weiß +	192406	47
				Schwarz +	192383	47

## DIMMABLE DRIVER\* Optionals

	Leistung	Output	Maß (LxH xB)	Art.-Nr.	€
1-10V	12W	250 mA	150x29x43 mm	217253	40
DALI	11W	250 mA	135x20x30 mm	202396	60



Light beam: ACCENT

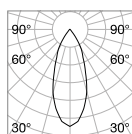

m	lx	øm
1	1545	0,69
2	386	1,38
3	171	2,07
4	96	2,77
5	61	3,46

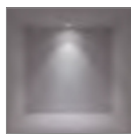

CRI≥90 11W 36° 850lm 3000K

\* Dimmbare Treiber müssen mit dem Artikel mitbestellt werden und werden bei dem Produkt anstelle der on-off Treiber eingebaut.



# One

Lichtquelle	LEDSMD	CRI	≥90
Leistung	2W /3W	LED Lebensdauer	30.000 h
Transformator	On/Off	Schutzklasse	II
inklusive		IP	20
Verfügbare	No	Material	Aluminium
Transformatore		Garantie	5Jahre
CCT	3000 K		

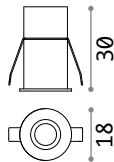

⌀ 17 mm  
0,050 Kg/0,0001 m<sup>3</sup>

LEDSMD ON/OFF Transformatorinklusive\*

Leistung	Beam	Lumen	CCT	Ausführ.	Art-Nr.	€
2 W	23°	130 lm	3000 K	Weiß	274768	31

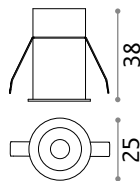

⌀ 25 mm  
0,070 Kg/0,0001 m<sup>3</sup>

LEDSMD ON/OFF Transformatorinklusive\*

Leistung	Beam	Lumen	CCT	Ausführ.	Art-Nr.	€
2 W	30°	130 lm	3000 K	Weiß	274775	37

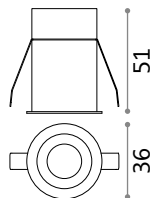

⌀ 35 mm  
0,100 Kg/0,0003 m<sup>3</sup>

LEDSMD ON/OFF Transformatorinklusive\*

Leistung	Beam	Lumen	CCT	Ausführ.	Art-Nr.	€
3 W	23°	270 lm	3000 K	Weiß	274782	41



Light beam: SPOT

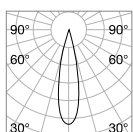

m	lx	øm
1	372	0,40
2	93	0,81
3	41	1,20
4	23	1,60
5	15	2,00



CRI≥90 2W 25° 65lm 3000K



Light beam: SPOT

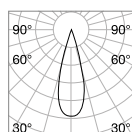

m	lx	øm
1	307	0,53
2	77	1,10
3	34	1,60
4	19	2,10
5	12	2,70



CRI≥90 2W 30° 70lm 3000K



Light beam: SPOT

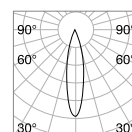

m	lx	øm
1	866	0,40
2	216	0,80
3	96	1,20
4	54	1,60
5	35	2,00



CRI≥90 3W 25° 65lm 3000K

\* Maß L 38,3 x H 16,5 x B 19,3mm

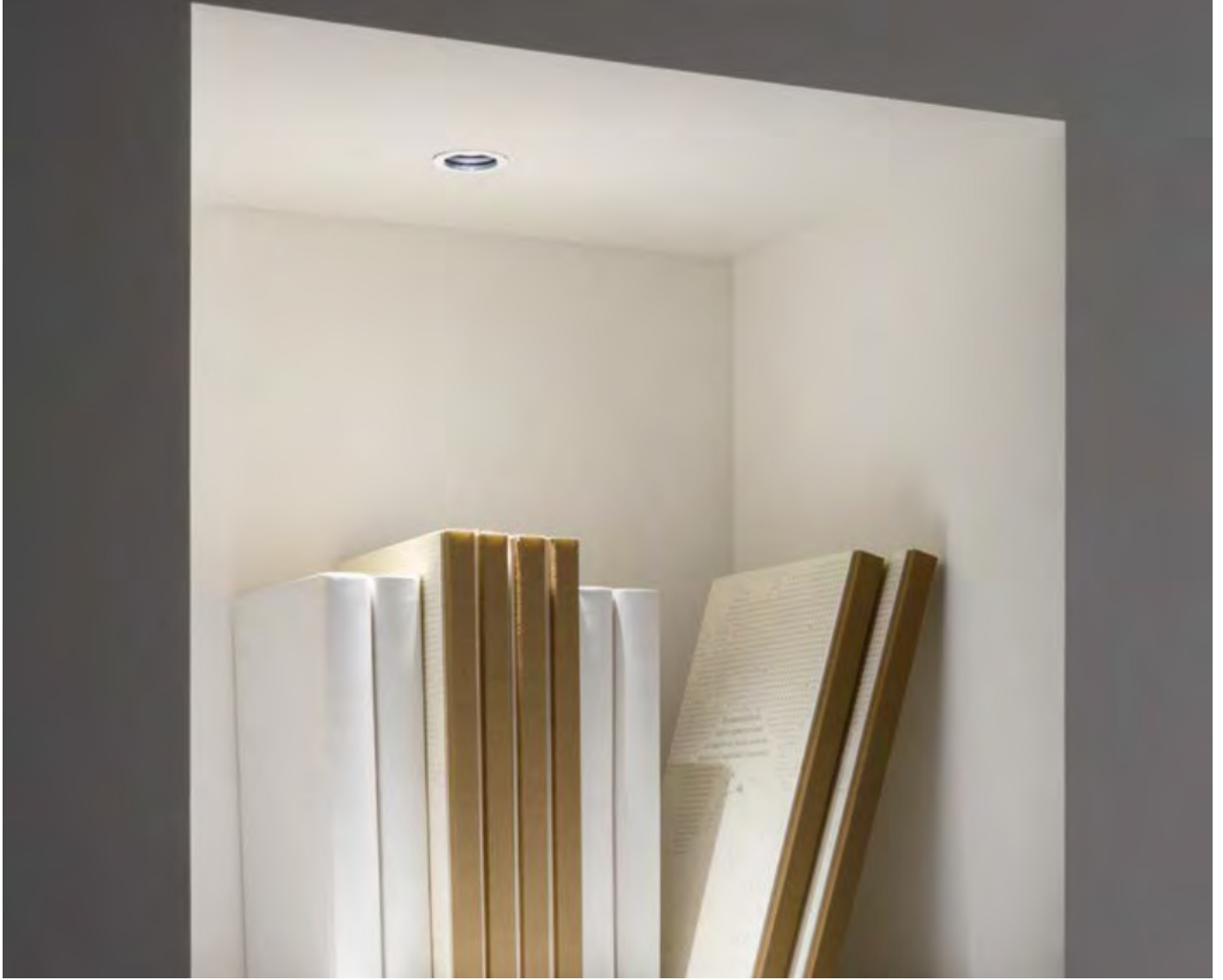



# Virus

☐ IP20 CRI ≥90 50.000h ALUMINIUM

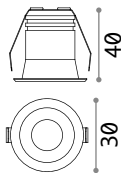

Ⓢ 30 mm  
0,070 Kg/0,0003 m<sup>3</sup>

LED SMD OSRAM AND DRIVER Inklusive

Leistung	Beam	Lumen	CCT	Ausführ.	Art-Nr.	€
3 W	20°	210 lm	3000 K	Weiß +	244808	32
				Gold +	244822	32
				Schwarz +	244846	32
				Gold +	244853	32



Light beam: SPOT

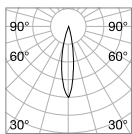

m	lx	Øm
1	1374	0,30
2	344	0,60
3	153	0,91
4	86	1,20
5	55	1,50



CRI≥90 3W 20° 210lm 3000K



244808



244822



244846



244853





# Quark

IP20 CRI ≥80 50.000 h ALUMINIUM

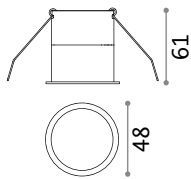

∅ 45 mm

0,170 Kg/0,0005 m<sup>3</sup>

LED COB CITIZEN AND DRIVER Inklusive

Leistung	Beam	Lumen	CCT	Ausführ.	Art-Nr.	€
8W	30°	720 lm	3000 K	Weiß	258478	57
				Schwarz	258461	57



Light beam: ACCENT

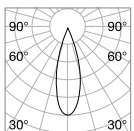

m	lk	øm
1	1446	0,54
2	362	1,10
3	161	1,60
4	90	2,20
5	56	2,70

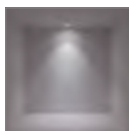

CRI≥80 8W 30° 550lm 3000K

# Off

Fixes Einbaugerät aus Aluminiumspritzguss mit rundem Ring in drei Größen, für Gipskartondecken geeignet. In Schwarz matt RAL 9005 und Weiß matt RAL 9016, LED integriert passiv gekühlt; hocheffiziente COB (Chip on Board) Technologie; UGR <19; Binning initial  $\leq 3$ -Step MacAdam; in Farbtemperaturen 3000 K und 4000 K erhältlich; frontaler Schutz IP54 (nach beendeter Installation); Schutzklasse II; optional mit 1-10V, DALI und Push dimmbar; Lebensdauer LED 50.000h L80B50. Geeignet für BÜROS und EXECUTIVE Räume mit Bildschirmarbeitsplätzen, wo nach hoher Blendschutz gefragt wird. Dank der hohen Farbwiedergabe, ist der Artikel ideal auch zur Beleuchtung von Ausstellungsflächen, und zum Hervorheben von Ausstellungs- und Verkaufsware in VERKAUFSFLÄCHEN.

**PRO** Hightech-Produkt mit hochwertigen Materialien, gedacht für einen professionellen Einsatz.

**UGR** Artikel mit UGR-Wert <19.

**IP54** Schutzart IP54.

Lichtquelle	LEDCOB
Leistung	15W /28W /42W
Transformator	On/Off
inklusive	
Verfügbare	1-10V/DALI /Push
Transformatore	
MacAdam	SDCM 3
CCT	3000 K /4000 K
CRI	$\geq 90$
UGR	<19
LED Lebensdauer	50.000 h
Schutzklasse	II
IP	54
Material	Aluminium
Garantie	5 Jahre





# Off

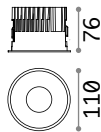

⌀ 100 mm  
0,460 Kg/0,0021 m<sup>3</sup>

## LED COB CITIZEN TRIDONIC ON/OFF Transfor.inklusive

Leistung	Beam	Lumen	CCT	Ausführ.	Art-Nr.	€
15W	50°	1350 lm	3000 K	Weiß	266497	86
				Schwarz	266558	86
		1450 lm	4000 K	Weiß	266503	86
				Schwarz	266565	86

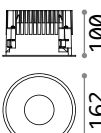

⌀ 150 mm  
0,990 Kg/0,0045 m<sup>3</sup>

## LED COB CITIZEN TRIDONIC ON/OFF Transfor.inklusive

Leistung	Beam	Lumen	CCT	Ausführ.	Art-Nr.	€
28 W	60°	2900 lm	3000 K	Weiß	266510	128
				Schwarz	266572	128
		3150 lm	4000 K	Weiß	266527	128
				Schwarz	266589	128

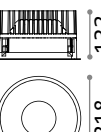

⌀ 195 mm  
1,850 Kg/0,0094 m<sup>3</sup>

## LED COB CITIZEN TRIDONIC ON/OFF Transfor.inklusive

Leistung	Beam	Lumen	CCT	Ausführ.	Art-Nr.	€
42 W	60°	4150 lm	3000 K	Weiß	266534	180
				Schwarz	266596	180
		4500 lm	4000 K	Weiß	266541	180
				Schwarz	266602	180



Modell	Erforderlich	Ausführ.	Art-Nr.	€
REFLECTOR Off 15W	Nein	Schwarz	266619	15
REFLECTOR Off 28W	Nein	Schwarz	266626	23
REFLECTOR Off 42W	Nein	Schwarz	266633	24

## DIMMABLE DRIVER\* Optionals

Modell	Kontrolle	Leistung	Output	Maß (LxH xB)	Art-Nr.	€
Off 15W	1-10V/Push	20 W	350 mA	105x20x50 mm	266657	70
	DALI	20 W	350 mA	105x20x50 mm	266701	70
Off 28W	1-10V/Push	22 W	700 mA	100x20x65 mm	266671	95
	DALI	32 W	700 mA	100x20x65 mm	266725	95
Off 42W	1-10V	42 W	1050 mA	120x20x75 mm	266688	115
	DALI/Push	45 W	1050 mA	150x30x43 mm	266732	110



Light beam: WIDE

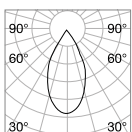

m	lx	øm
1	1688	0,93
2	422	1,90
3	188	2,80
4	105	3,70
5	68	4,60

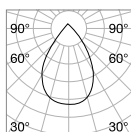
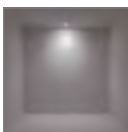

m	lx	øm
1	2457	1,30
2	614	2,50
3	273	3,80
4	154	5,10
5	98	6,40

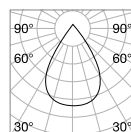
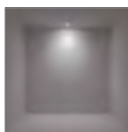

m	lx	øm
1	3496	1,20
2	874	2,40
3	388	3,60
4	218	4,80
5	140	6,00

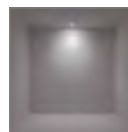

CRI≥90 15W 50° 1100lm 3000K

CRI≥90 28W 60° 2300lm 3000K

CRI≥90 42W 60° 4600lm 3000K

\* Dimmbare Treiber müssen mit dem Artikel mitbestellt werden und werden bei dem Produkt anstelle der on-off Treiber eingebaut.



# Deep

Lichtquelle LEDSMD  
 Leistung 10W /20W /30W  
 Transformator On/Off  
 inklusive  
 Verfügbare 1-10V/DALI /Push  
 Transformatore  
 CCT 3000 K /4000 K

CRI  $\geq 80$   
 LED Lebensdauer 50.000 h  
 Schutzklasse II  
 IP 20  
 Material Aluminium  
 Garantie 5 Jahre

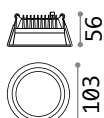

⌀ 90 mm

0,160 Kg/0,0014 m<sup>3</sup>

LEDSMD ON/OFF Transformator inklusive

Leistung	Beam	Lumen	CCT	Ausführ.	Art-Nr.	€
10W	70°	1350 lm	3000 K	Weiß	249018	28
		1450 lm	4000 K	Weiß	249025	28

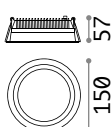

⌀ 145 mm

0,360 Kg/0,0037 m<sup>3</sup>

LEDSMD ON/OFF Transformator inklusive

Leistung	Beam	Lumen	CCT	Ausführ.	Art-Nr.	€
20W	77°	2750 lm	3000 K	Weiß	249032	62
		2950 lm	4000 K	Weiß	249049	62

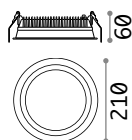

⌀ 200 mm

0,650 Kg/0,0053 m<sup>3</sup>

LEDSMD ON/OFF Transformator inklusive

Leistung	Beam	Lumen	CCT	Ausführ.	Art-Nr.	€
30W	77°	4150 lm	3000 K	Weiß	248783	84
		4350 lm	4000 K	Weiß	248790	84

DIMMABLE DRIVER\* Optionals

Modell	Kontrolle	Leistung	Output	Maß (LxH xB)	Art-Nr.	€
Deep 10W	1-10V	10W	300 mA	135x20x30 mm	248950	57
	DALI	12W	300 mA	135x20x30 mm	248967	57
Deep 20W	1-10V/Push	25 W	500 mA	167x32x41mm	248974	98
	DALI/Push	25 W	500 mA	167x32x41mm	248981	98
Deep 30W	1-10V/Push	30 W	750 mA	167x32x41mm	248998	105
	DALI/Push	36 W	700 mA	167x30x39 mm	249001	105



Light beam: WIDE

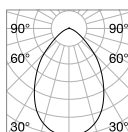

m	lx	Øm
1	625	1,43
2	156	2,86
3	69	4,30
4	39	5,73
5	25	7,16

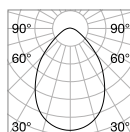
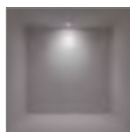

m	lx	Øm
1	1056	1,60
2	264	3,20
3	117	4,81
4	66	6,41
5	42	8,01

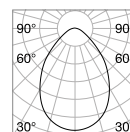
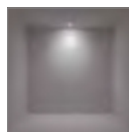

m	lx	Øm
1	1644	1,60
2	411	3,20
3	183	4,81
4	103	6,41
5	66	8,01

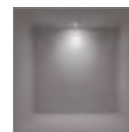

CRI $\geq 80$  10W 70° 1200lm 3000K

CRI $\geq 80$  20W 77° 2100lm 3000K

CRI $\geq 80$  30W 77° 3200lm 3000K

\* Dimmbare Treiber müssen mit dem Artikel mitbestellt werden und werden bei dem Produkt anstelle der on-off Treiber eingebaut.



# Basic

Einbaustrahler aus Aluminiumspritzguss mit rundem Ring, für Einbau in Gipskartondecken geeignet. Ausführung weiß matt; COB (Chip on Board) und SMD Technologie; lieferbar in den Lichtfarben 3000 K und 4000 K und mit drei verschiedenen Linsen; CRI  $\geq 80$ ; frontaler Schutz IP44 (nach beendeter Installation); Schutzklasse II; Lebensdauer LED 30.000h L70B50.

**IP44** Schutzart IP44.

Lichtquelle	LED COB /SMD
Leistung	10W /15W /20W /30W
Transformator	On/Off
inklusive	
Verfügbare	1-10V/DALI /Push
Transformatore	
MacAdam	SDCM $\leq 3$
CCT	3000 K /4000 K
CRI	$\geq 80$
LED Lebensdauer	30.000 h
Schutzklasse	II
IP	44
Material	Aluminium
Garantie	5 Jahre

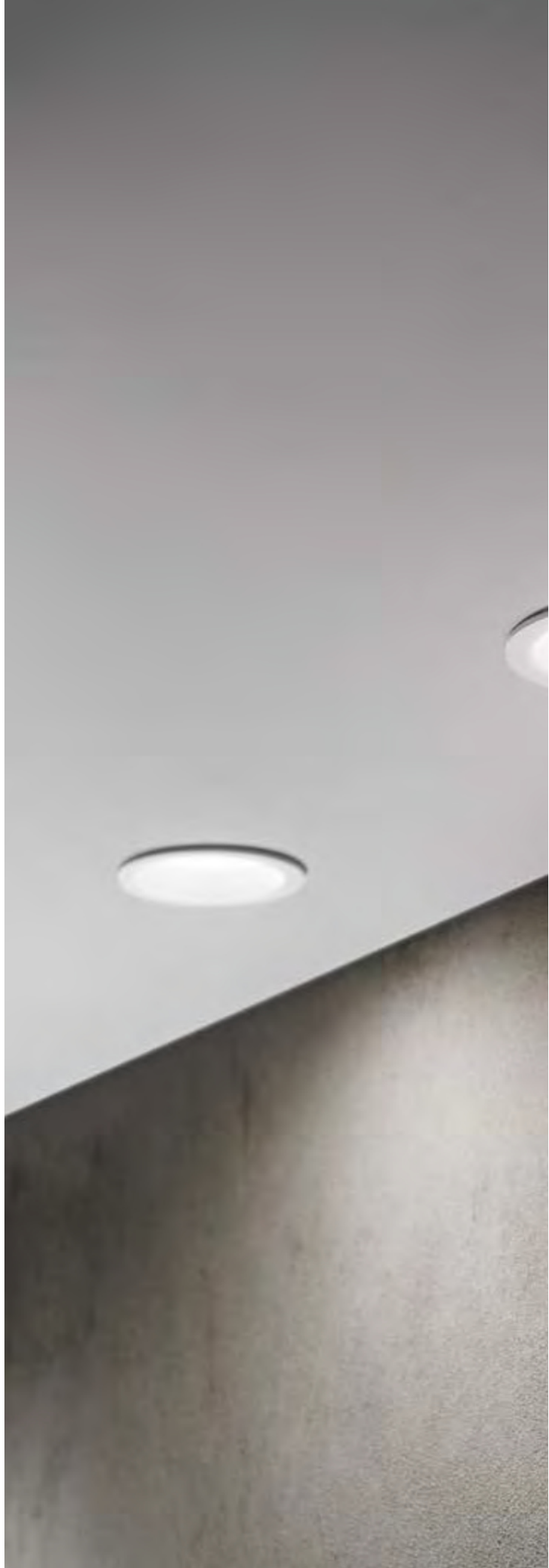





# Basic Accent

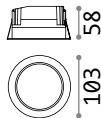

① 90 mm  
0,400 Kg/0,0017 m<sup>3</sup>

## LED COB PHILIPS PHILIPS ON/OFF Transformatorinklusive

Leistung	Beam	Lumen	CCT	Ausführ.	Art.-Nr.	€
10W	45°	1050 lm	3000 K	Weiß	193458	68
		1200 lm	4000 K	Weiß	193359	68

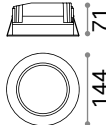

① 125 mm  
0,660 Kg/0,0027 m<sup>3</sup>

## LED COB PHILIPS PHILIPS ON/OFF Transformatorinklusive

Leistung	Beam	Lumen	CCT	Ausführ.	Art.-Nr.	€
15W	52°	1500 lm	3000 K	Weiß	193465	85
		1550 lm	4000 K	Weiß	193366	85
20 W		1950 lm	3000 K	Weiß	193472	90
		2050 lm	4000 K	Weiß	193373	90

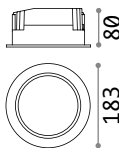

① 160 mm  
1,250 Kg/0,0056 m<sup>3</sup>

## LED COB PHILIPS PHILIPS ON/OFF Transformatorinklusive

Leistung	Beam	Lumen	CCT	Ausführ.	Art.-Nr.	€
30 W	46°	2500 lm	3000 K	Weiß	193489	145
		2550 lm	4000 K	Weiß	193380	145

## DIMMABLE DRIVER\* Optionals

Modell	Kontrolle	Leistung	Output	Maß (LxH xB)	Art.-Nr.	€
Basic 10W	1-10V	12W	300 mA	150x29x43 mm	218823	40
	DALI/Push	10W	300 mA	130x30x43 mm	220772	125
Basic 15W	1-10V	15W	450 mA	150x29x43 mm	218830	45
	DALI/Push	17W	450 mA	130x30x43 mm	220796	134
Basic 20W	DALI/Push	25 W	700 mA	130x30x43 mm	220789	146
Basic 30W	1-10V	31W	900 mA	150x29x43 mm	218854	50
	DALI/Push	45 W	900 mA	150x30x43 mm	220802	158



Light beam: ACCENT

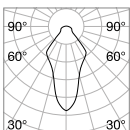

m	lx	Øm
1	533	0,81
2	133	1,62
3	59	2,44
4	33	3,25
5	21	4,07

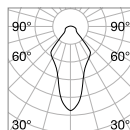
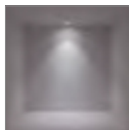

m	lx	Øm
1	719	0,98
2	179	1,96
3	79	2,95
4	44	3,93
5	28	4,92

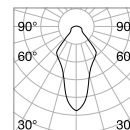
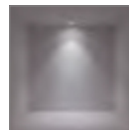

m	lx	Øm
1	1250	0,92
2	312	1,84
3	138	2,76
4	78	3,69
5	50	4,61



CRI≥80 10W 45° 1000lm 3000K

CRI≥80 15W 52° 1550lm 3000K

CRI≥80 30W 46° 2900lm 3000K

\* Dimmbare Treiber müssen mit dem Artikel mitbestellt werden und werden bei dem Produkt anstelle der on-off Treiber eingebaut.



# Basic Wide

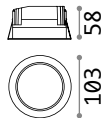

① 90 mm  
0,370 Kg/0,0017 m<sup>3</sup>

## LED SMD SAMSUNG PHILIPS ON/OFF Transformatorinklusive

Leistung	Beam	Lumen	CCT	Ausführ.	Art.-Nr.	€
10W	85°	1150lm	3000 K	Weiß	193519	65
		1200lm	4000 K	Weiß	193403	65

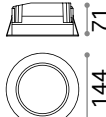

① 125 mm  
0,630 Kg/0,0027 m<sup>3</sup>

## LED SMD SAMSUNG PHILIPS ON/OFF Transformatorinklusive

Leistung	Beam	Lumen	CCT	Ausführ.	Art.-Nr.	€
15W	87°	1750lm	3000 K	Weiß	193526	80
		1800lm	4000 K	Weiß	193410	80
20 W		2400 lm	3000 K	Weiß	193533	85
		2500 lm	4000 K	Weiß	193427	85

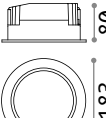

① 160 mm  
1,130 Kg/0,0056 m<sup>3</sup>

## LED SMD SAMSUNG PHILIPS ON/OFF Transformatorinklusive

Leistung	Beam	Lumen	CCT	Ausführ.	Art.-Nr.	€
30 W	90°	3050 lm	3000 K	Weiß	193540	140
		3150 lm	4000 K	Weiß	193434	140

## DIMMABLE DRIVER\* Optionals

Modell	Kontrolle	Leistung	Output	Maß (LxH xB)	Art.-Nr.	€
Basic 10W	1-10V	12W	300 mA	150x29x43 mm	218823	40
	DALI/Push	10W	300 mA	130x30x43 mm	220772	125
Basic 15W	1-10V	15W	450 mA	150x29x43 mm	218830	45
	DALI/Push	17W	450 mA	130x30x43 mm	220796	134
Basic 20W	DALI/Push	25 W	700 mA	130x30x43 mm	220789	146
Basic 30W	1-10V	31W	900 mA	150x29x43 mm	218854	50
	DALI/Push	45 W	900 mA	150x30x43 mm	220802	158



Light beam: WIDE

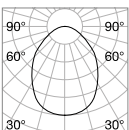

m	lx	Øm
1	188	1,84
2	47	3,69
3	20	5,54
4	11	7,39
5	7	9,24

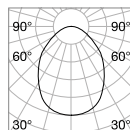
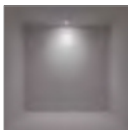

m	lx	Øm
1	318	1,72
2	79	3,44
3	35	5,17
4	19	6,89
5	12	8,61

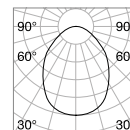
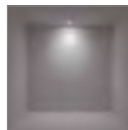

m	lx	Øm
1	591	1,84
2	147	3,69
3	65	5,53
4	36	7,38
5	23	9,23

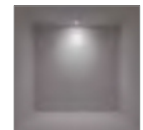

CRI≥80 10W 85° 1000lm 3000K

CRI≥80 15W 87° 1500lm 3000K

CRI≥80 30W 90° 2900lm 3000K

\* Dimmbare Treiber müssen mit dem Artikel mitbestellt werden und werden bei dem Produkt anstelle der on-off Treiber eingebaut.



# Groove

IP20 CRI ≥80 30.000 h ALUMINIUM

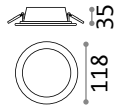

① 100 mm

0,220 Kg/0,0012 m<sup>3</sup>

## LEDSMDANDDRIVER Inklusive

Leistung	Beam	Lumen	CCT	Ausführ.	Art-Nr.	€
10W	110°	1250 lm	3000 K	Weiß	123974	25
		1350 lm	4000 K	Weiß	147666	25

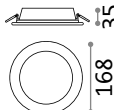

① 150 mm

0,410 Kg/0,0023 m<sup>3</sup>

## LEDSMDANDDRIVER Inklusive

Leistung	Beam	Lumen	CCT	Ausführ.	Art-Nr.	€
20W	110°	2600 lm	3000 K	Weiß	123998	34
		2700 lm	4000 K	Weiß	147673	34

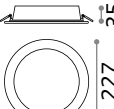

① 205 mm

0,660 Kg/0,0036 m<sup>3</sup>

## LEDSMDANDDRIVER Inklusive

Leistung	Beam	Lumen	CCT	Ausführ.	Art-Nr.	€
30W	110°	3800 lm	3000 K	Weiß	124018	46
		4050 lm	4000 K	Weiß	147680	46

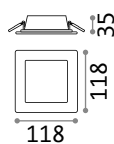

Ⓐ 100 x 100 mm

0,270 Kg/0,0012 m<sup>3</sup>

## LEDSMDANDDRIVER Inklusive

Leistung	Beam	Lumen	CCT	Ausführ.	Art-Nr.	€
10W	110°	1200 lm	3000 K	Weiß	123981	26

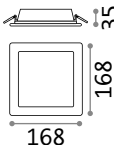

Ⓐ 150 x 150 mm

0,540 Kg/0,0023 m<sup>3</sup>

## LEDSMDANDDRIVER Inklusive

Leistung	Beam	Lumen	CCT	Ausführ.	Art-Nr.	€
20W	110°	2450 lm	3000 K	Weiß	124001	36

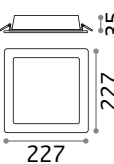

Ⓐ 205 x 205 mm

0,850 Kg/0,0036 m<sup>3</sup>

## LEDSMDANDDRIVER Inklusive

Leistung	Beam	Lumen	CCT	Ausführ.	Art-Nr.	€
30W	110°	3900 lm	3000 K	Weiß	124025	49



Light beam: WIDE



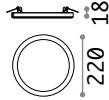

⌀ min 65-max 205 mm  
0,350 Kg/0,0018 m<sup>3</sup>

**LEDSMDANDDRIVER** Inklusive

Leistung	Beam	Lumen	CCT	Ausführ.	Art-Nr.	€
20 W	115°	1950 lm	3000 K	Weiß	290799	50 <small>new</small>
				Schwarz	290775	50 <small>new</small>
		2000 lm	4000 K	Weiß	306346	50 <small>new</small>
				Schwarz	306360	50 <small>new</small>

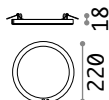

⌀ min 65-max 205 mm  
0,350 Kg/0,0018 m<sup>3</sup>

**LEDSMDANDDRIVER** Inklusive –Bewegungsmelder PIR und Dämmerungs.



Leistung	Beam	Lumen	CCT	Ausführ.	Art-Nr.	€
20 W	115°	1950 lm	3000 K	Weiß	290805	60 <small>new</small>
				Schwarz	290782	60 <small>new</small>
		2000 lm	4000 K	Weiß	306353	60 <small>new</small>
				Schwarz	306377	60 <small>new</small>

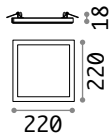

⌀ min 65-max 205 mm  
0,400 Kg/0,0018 m<sup>3</sup>

**LEDSMDANDDRIVER** Inklusive

Leistung	Beam	Lumen	CCT	Ausführ.	Art-Nr.	€
20 W	115°	1950 lm	3000 K	Weiß	290836	58 <small>new</small>
				Schwarz	290812	58 <small>new</small>
		2000 lm	4000 K	Weiß	306384	58 <small>new</small>
				Schwarz	306407	58 <small>new</small>

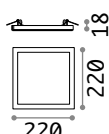

⌀ min 65-max 205 mm  
0,400 Kg/0,0018 m<sup>3</sup>

**LEDSMDANDDRIVER** Inklusive –Bewegungsmelder PIR und Dämmerungs.



Leistung	Beam	Lumen	CCT	Ausführ.	Art-Nr.	€
20 W	115°	1950 lm	3000 K	Weiß	290843	66 <small>new</small>
				Schwarz	290829	66 <small>new</small>
		2000 lm	4000 K	Weiß	306391	66 <small>new</small>
				Schwarz	306414	66 <small>new</small>



Light beam: WIDE









# Play

☐ IP20 CRI ≥90 30.000h ALUMINIUM

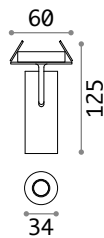

LED COB AND DRIVER Inklusive

Leistung	Beam	Lumen	CCT	Ausführ.	Art.-Nr.	€
7W	17°	520 lm	3000K	Weiß	258270	70
				Schwarz	268088	70

90° 355° 45 mm
   
 0,220 Kg/0,0014 m<sup>3</sup>



Light beam: SPOT



P. 307



# Channel

IP20 ALUMINIUM

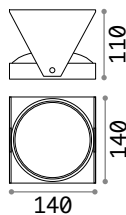

**GU10** Leuchtmittel LED GU10 10W 3000 K inklusive. Art.-Nr. 189031

Leistung	Ausführ.	Art.-Nr.	€
max 13W	Schwarz	203140	85

0,490 Kg/0,0037 m<sup>3</sup>

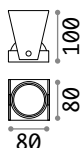

**GU10** Leuchtmittel LED GU10 7W 3000 K inklusive. Art.-Nr. 123943

Leistung	Ausführ.	Art.-Nr.	€
max 7W	Schwarz	203133	52

0,170 Kg/0,0017 m<sup>3</sup>

# Nova

Lichtquelle	LEDCOB	CRI	≥90
Leistung	12W /30W	LED Lebensdauer	50.000 h
Transformator	On/Off	Schutzklasse	II
inklusive		IP	20
Verfügbare	1-10V/DALI /Push	Material	Aluminium
Transformatore		Garantie	5Jahre
CCT	3000 K /4000 K		

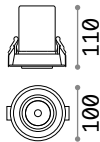

90° 360° 90 mm  
0,550 Kg/0,0016 m³

## LED COB PHILIPS ON/OFF Transformator inklusive – UGR <19

Leistung	Beam	Lumen	CCT	Ausführ.	Art-Nr.	€
12W	38°	1000 lm	3000 K	Weiß	248165	75
				Schwarz	248189	75
		1100 lm	4000 K	Weiß	267937	75
				Schwarz	267920	75

## DIMMABLE DRIVER\* Optionals

	Leistung	Output	Maß (LxH xB)	Art-Nr.	€
1-10V/Push	15W	300 mA	167x31x41mm	243993	60
DALI	12W	300 mA	135x20x30 mm	243986	50

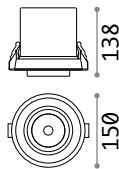

90° 360° 140 mm  
1,160 Kg/0,0039 m³

## LED COB PHILIPS ON/OFF Transformator inklusive – UGR <22

Leistung	Beam	Lumen	CCT	Ausführ.	Art-Nr.	€
30 W	38°	3000 lm	3000 K	Weiß	248172	125
				Schwarz	248196	125
		3250 lm	4000 K	Weiß	267951	125
				Schwarz	267944	125

## DIMMABLE DRIVER\* Optionals

	Leistung	Output	Maß (LxH xB)	Art-Nr.	€
1-10V/Push	36 W	750 mA	167x32x41mm	248370	90
DALI/Push	36 W	700 mA	167x30x39 mm	248592	105



## LENS

Modell	Erforderlich	Beam	Art-Nr.	€
Nova 12W	Nein	15°	244013	6
Nova 30W	Nein	15°	248608	12



Light beam: ACCENT

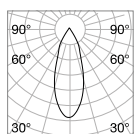

m	lx	øm
1	1768	0,66
2	442	1,32
3	196	1,97
4	111	2,63
5	71	3,29

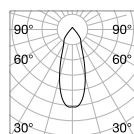

m	lx	øm
1	4671	0,64
2	1168	1,28
3	519	1,93
4	292	2,57
5	187	3,21



CRI≥90 12W 38° 1000lm 3000K

CRI≥90 30W 38° 3150lm 3000K

\* Dimmbare Treiber müssen mit dem Artikel mitbestellt werden und werden bei dem Produkt anstelle der on-off Treiber eingebaut.



# Led Panel

Lichtquelle	LEDSMD	CRI	≥80 / ≥90
Leistung	40W	UGR	<19
Transformator	On/Off	LED Lebensdauer	25.000 h
inklusive		Schutzklasse	II
Verfügbare	1-10V/DALI /Push	IP	20
Transformatore		Material	Aluminium
CCT	3000 K /4000 K	Garantie	5 Jahre

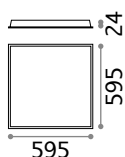

2,200 Kg/0,0144 m<sup>3</sup>  
Bestellmenge 2 Stk.

## LED SMD ON/OFF Transformator inklusive

CRI ≥80

Leistung	Beam	Lumen	CCT	Ausführ.	Art-Nr.	€
40 W	81°	4150 lm	3000 K	Weiß	249711	45
		4450 lm	4000 K	Weiß	249728	45

CRI ≥90

Leistung	Beam	Lumen	CCT	Ausführ.	Art-Nr.	€
40 W	81°	3550 lm	3000 K	Weiß	246390	45
		3800 lm	4000 K	Weiß	244181	45

## DIMMABLE DRIVER\* Optionals

	Leistung	Output	Maß (LxHxB)	Art-Nr.	€
1-10V	42 W	1000 mA	125x26x83 mm	247854	37
DALI/Push	45 W	1000 mA	106x28x69 mm	247847	67



KITPENDANT

KITSURFACE

RECESSEDFRAME\*\*

Erforderlich	Kabelanz.	Kabellänge	Art-Nr.	€
Nein	4	1000 mm	244198	6
Nein			244204	6
Nein			267692	17



Light beam: WIDE

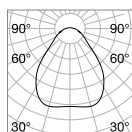

m	lx	Øm
1	1470	1,79
2	367	3,59
3	163	5,38
4	92	7,18
5	59	8,97

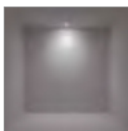

\* Dimmbare Treiber müssen mit dem Artikel mitbestellt werden und werden bei dem Produkt anstelle der on-off Treiber eingebaut.

CRI≥80 38,5W 81° 3800lm 3000K

\*\*RECESSED FRAME 607 x 607 mm

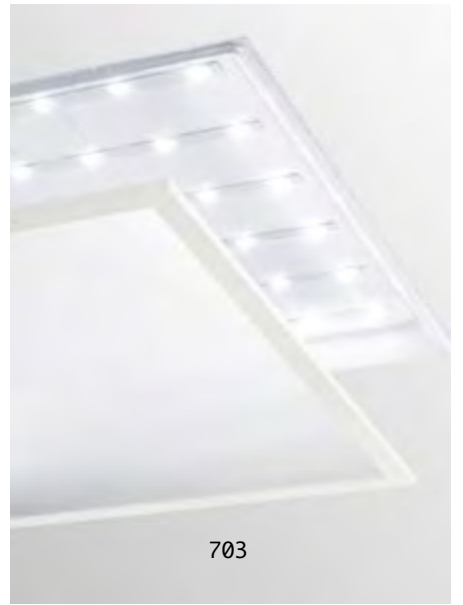
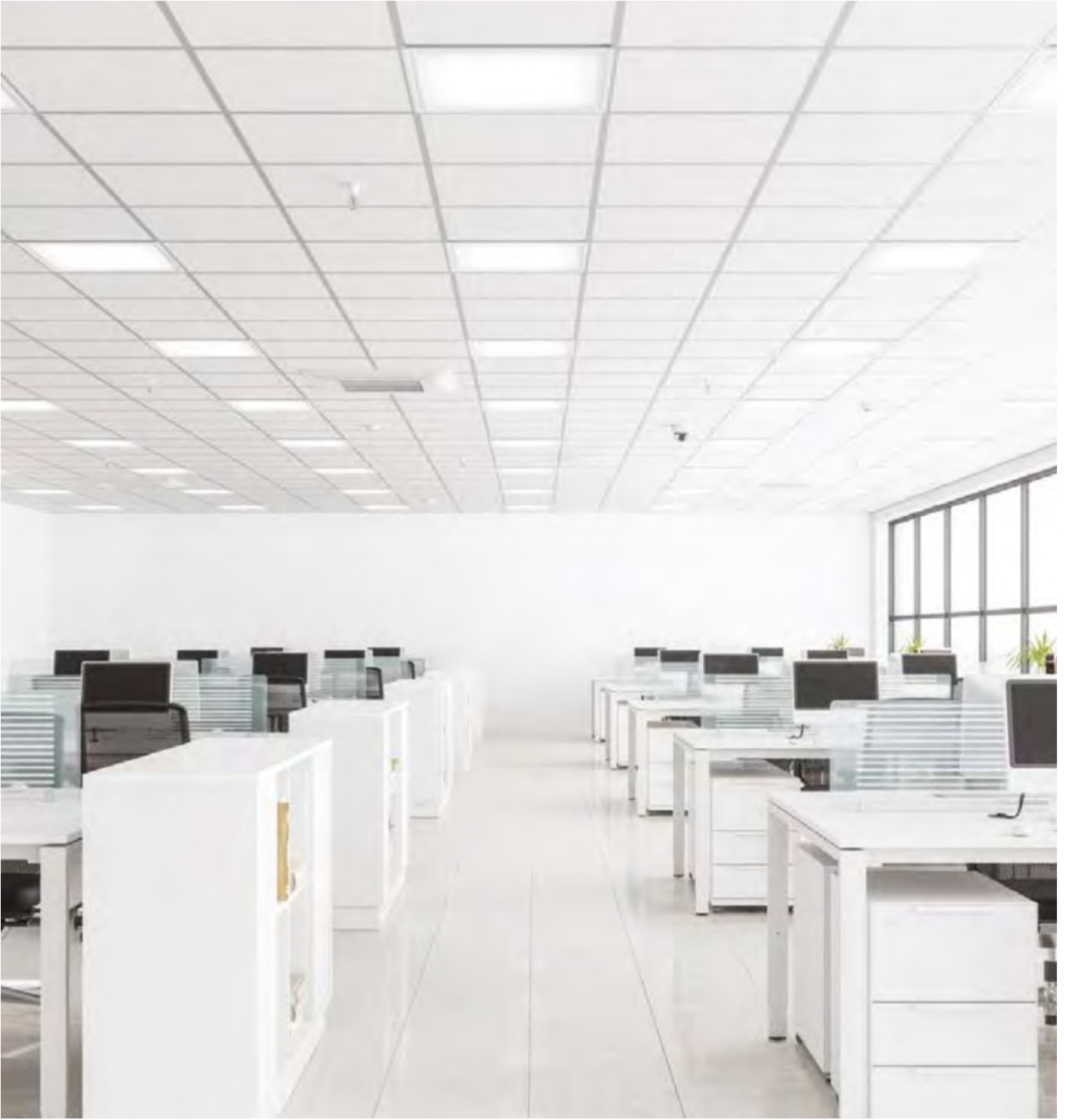

# Lika

LED-Module mit rechteckigem Einbau aus Aluminiumspritzguss schwarz oder weiß lackiert, mit Reflektor aus Polycarbonat schwarz glänzend. Lieferbar in den Varianten TRIM mit umlaufendem Rand und TRIMLESS mit zurückgesetztem Rand für versenkten Einbau in Gipskartondecken. Module mit zwei, fünf oder zehn Lichtquellen erhältlich. Speziell entwickelt, um vor Blendungen zu schützen (UGR <16), ist die Produktfamilie für BÜROS und GEWERBEFLÄCHEN, oder minimalistische Wohnräume besonders geeignet. Lichtquelle mit LED integriert; in Farbtemperaturen 3000 K und 4000 K verfügbar; CRI ≥90; IP20 Schutz, Isolationsklasse II; Lebensdauer LED 50.000h L70B50.

**UGR** Artikel mit UGR-Wert <16.

Lichtquelle	LEDCOB
Leistung	6W /12W /20W
Transformator	On/Off
inklusive	
Verfügbare	DALI /Push
Transformatore	
CCT	3000 K /4000 K
CRI	≥90
UGR	<16
LED Lebensdauer	50.000 h
Schutzklasse	II
IP	20
Material	Aluminium
Garantie	5 Jahre







# Lika Trim

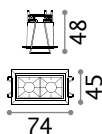

68 x 37 mm  
0,130 Kg/0,0005 m<sup>3</sup>

## LED COB OSRAM ON/OFF Transformator inklusive

Leistung	Beam	Lumen	CCT	Ausführ.	Art-Nr.	€
6W	29°	480 lm	3000 K	Schwarz	+ 206196	45
		520 lm	4000 K	Schwarz	+ 267869	45

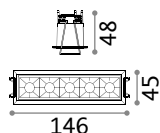

140 x 37 mm  
0,240 Kg/0,0008 m<sup>3</sup>

## LED COB OSRAM ON/OFF Transformator inklusive

Leistung	Beam	Lumen	CCT	Ausführ.	Art-Nr.	€
12W	29°	1200 lm	3000 K	Schwarz	+ 206219	65
		1250 lm	4000 K	Schwarz	+ 267876	65

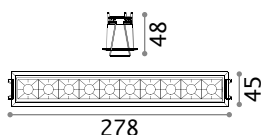

273 x 37 mm  
0,480 Kg/0,0016 m<sup>3</sup>

## LED COB OSRAM ON/OFF Transformator inklusive

Leistung	Beam	Lumen	CCT	Ausführ.	Art-Nr.	€
20W	29°	1750 lm	3000 K	Schwarz	+ 206233	110
		1850 lm	4000 K	Schwarz	+ 267883	110

## DIMMABLE DRIVER\* Optionals

Modell	Kontrolle	Leistung	Output	Maß (LxH xB)	Art-Nr.	€
Lika 6W	DALI	10W	700 mA	135x20x30 mm	267982	56
Lika 12W	DALI	12W	700 mA	135x20x30 mm	267999	56
Lika 20W	DALI/Push	25 W	600 mA	167x32x41mm	268002	104



Light beam: ACCENT

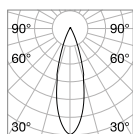

m	lx	cm
1	2091	0,58
2	523	1,16
3	232	1,74
4	131	2,32
5	70	2,90

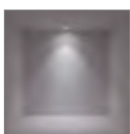

CRI≥90 12,5W 29° 1100lm 3000K

\* Dimmbare Treiber müssen mit dem Artikel mitbestellt werden und werden bei dem Produkt anstelle der on-off Treiber eingebaut.



# Lika Trimless

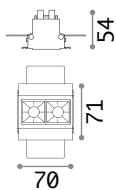

75 x 70 mm  
0,220 Kg/0,0006 m<sup>3</sup>

## LED COB OSRAM ON/OFF Transformator inklusive

Leistung	Beam	Lumen	CCT	Ausführ.	Art-Nr.	€
6W	29°	480 lm	3000 K	Schwarz	206202	60
		520 lm	4000 K	Schwarz	267890	60

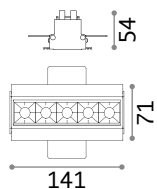

145 x 70 mm  
0,390 Kg/0,0013 m<sup>3</sup>

## LED COB OSRAM ON/OFF Transformator inklusive

Leistung	Beam	Lumen	CCT	Ausführ.	Art-Nr.	€
12W	29°	1200 lm	3000 K	Schwarz	206226	95
		1250 lm	4000 K	Schwarz	267906	95

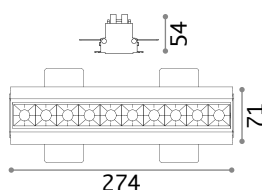

278 x 70 mm  
0,720 Kg/0,0023 m<sup>3</sup>

## LED COB OSRAM ON/OFF Transformator inklusive

Leistung	Beam	Lumen	CCT	Ausführ.	Art-Nr.	€
20W	29°	1750 lm	3000 K	Schwarz	206240	151
		1850 lm	4000 K	Schwarz	267913	151

## DIMMABLE DRIVER\* Optionals

Modell	Kontrolle	Leistung	Output	Maß (LxHxB)	Art-Nr.	€
Lika 6W	DALI	10W	700 mA	135x20x30 mm	267982	56
Lika 12W	DALI	12W	700 mA	135x20x30 mm	267999	56
Lika 20W	DALI/Push	25 W	600 mA	167x32x41mm	268002	104



Light beam: ACCENT

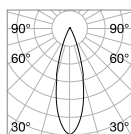

m	lx	Øm
1	2786	0,58
2	696	1,16
3	309	1,74
4	174	2,32
5	111	2,90



CRI≥90 12,5W 29° 1100lm 3000K

\* Dimmbare Treiber müssen mit dem Artikel mitbestellt werden und werden bei dem Produkt anstelle der on-off Treiber eingebaut.



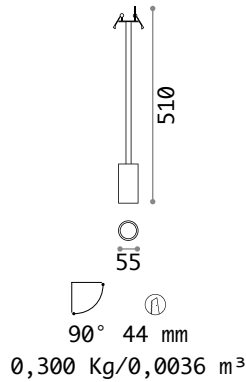

## GU10 Leuchtmittel LED GU10 7W 3000 K inklusive.Art.-Nr.123943

Leistung	Ausführ.	Art.-Nr.	€
max28W	Weiß	296401	36 <small>new</small>
	Schwarz	296395	36 <small>new</small>

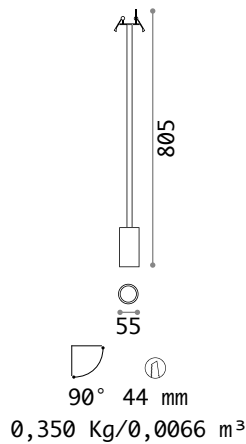

## GU10 Leuchtmittel LED GU10 7W 3000 K inklusive.Art.-Nr.123943

Leistung	Ausführ.	Art.-Nr.	€
max28W	Weiß	296388	41 <small>new</small>
	Schwarz	296371	41 <small>new</small>



Light beam: SPOT

# Eye

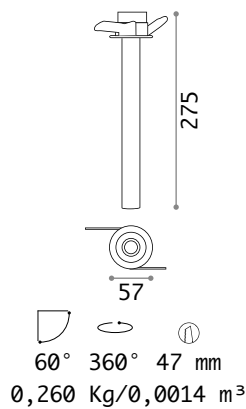

## LEDCOB ANDDRIVER Inklusive

Leistung	Beam	Lumen	CCT	Ausführ.	Art.-Nr.	€
2,5 W	15°	270 lm	3000 K	Weiß	186986	85



Light beam: SPOT



# Zephyr

IP20 GIPS

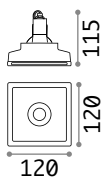

123 x 123 mm  
0,880 Kg/0,0032 m<sup>3</sup>

**GU10 Nicht inklusive –Empfohlenes Leuchtmittel** 108292

Leistung	Ausführ.	Art.-Nr.	€
max 35W	Weiß	150284	19

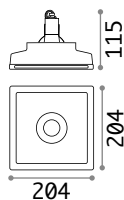

20° 110° 207 x 207 mm  
1,350 Kg/0,0075 m<sup>3</sup>

**GU10 Nicht inklusive –Empfohlenes Leuchtmittel** 108292

Leistung	Ausführ.	Art.-Nr.	€
max 35W	Weiß	155722	61

# Samba

IP20 GIPS

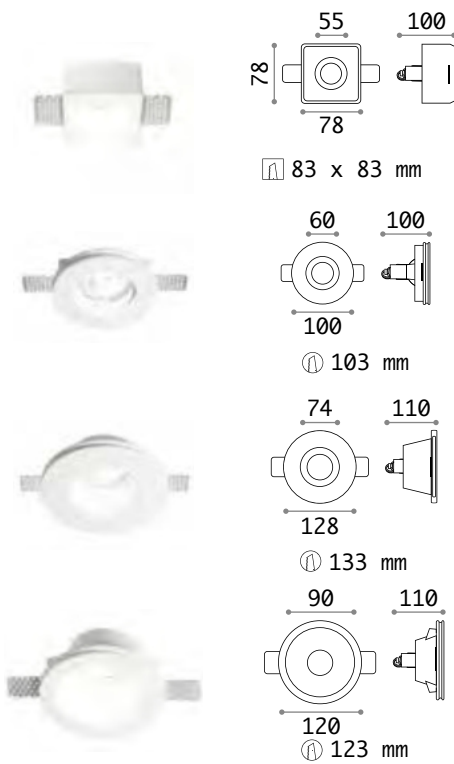

## GU10 Nicht inklusive –Empfohlenes Leuchtmittel 108292

Leistung	Gewicht	Volumen	Ausführ.	Art-Nr.	€
max 35W	0,360 Kg	0,0016 m <sup>3</sup>	Weiß	230580	15

Leistung	Gewicht	Volumen	Ausführ.	Art-Nr.	€
max 35W	0,230 Kg	0,0018 m <sup>3</sup>	Weiß	150307	15

Leistung	Gewicht	Volumen	Ausführ.	Art-Nr.	€
max 35W	0,450 Kg	0,0032 m <sup>3</sup>	Weiß	150130	15

Leistung	Gewicht	Volumen	Ausführ.	Art-Nr.	€
max 50W	0,340 Kg	0,0022 m <sup>3</sup>	Weiß	139012	15

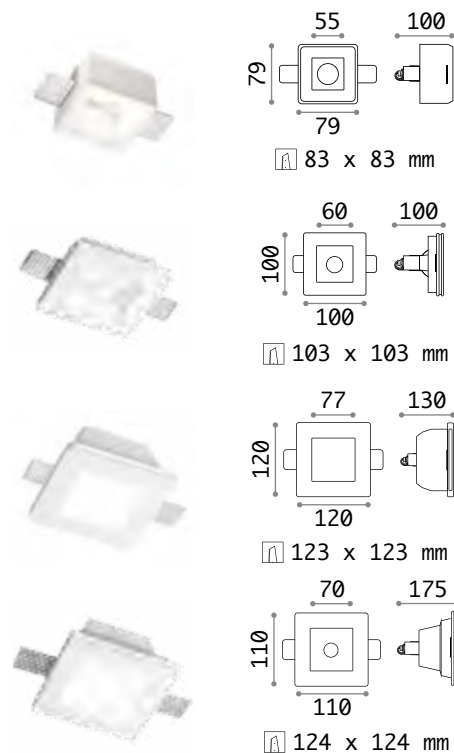

## GU10 Nicht inklusive –Empfohlenes Leuchtmittel 108292

Leistung	Gewicht	Volumen	Ausführ.	Art-Nr.	€
max 35W	0,330 Kg	0,0016 m <sup>3</sup>	Weiß	229997	15

Leistung	Gewicht	Volumen	Ausführ.	Art-Nr.	€
max 35W	0,320 Kg	0,0018 m <sup>3</sup>	Weiß	150291	15

Leistung	Gewicht	Volumen	Ausführ.	Art-Nr.	€
max 35W	0,600 Kg	0,0037 m <sup>3</sup>	Weiß	150116	15

## Lichtverteiler aus Glas

Leistung	Gewicht	Volumen	Ausführ.	Art-Nr.	€
max 50W	0,430 Kg	0,0023 m <sup>3</sup>	Weiß	139029	15



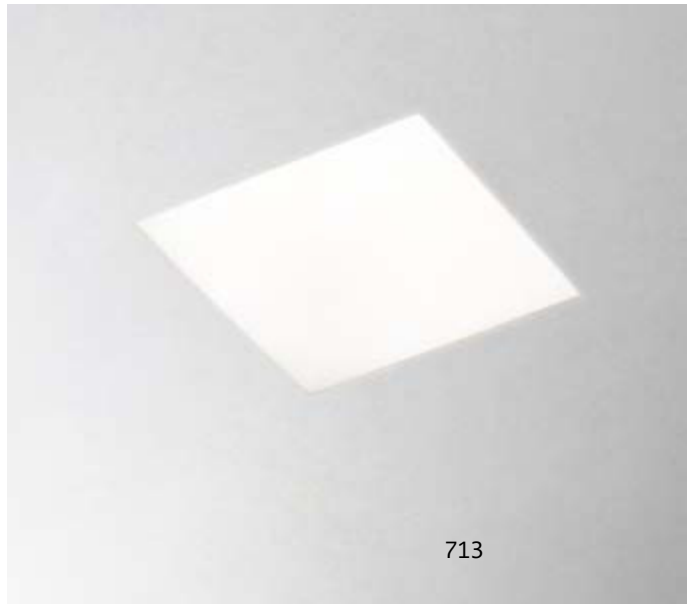

# Jazz

IP20 ZINK

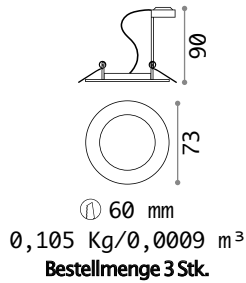

GU10 Nicht inklusive–Empfohlenes Leuchtmittel 108292

Leistung	Ausführ.	Art.-Nr.	€
max 50W	Weiß	083117	10
	Brüniert	083124	10
	Chrom	083070	10
	Schwarz	243818	10
	Nickel	083087	10

# Swing

IP20 ZINK

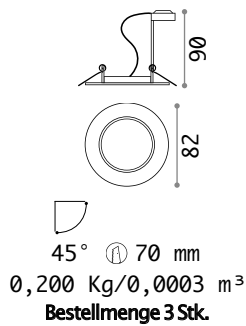

GU10 Nicht inklusive–Empfohlenes Leuchtmittel 108292

Leistung	Ausführ.	Art.-Nr.	€
max 50W	Weiß	083179	12
	Brüniert	083186	12
	Chrom	083131	12
	Schwarz	243825	12
	Nickel	083148	12

# Lounge

IP20 ZINK

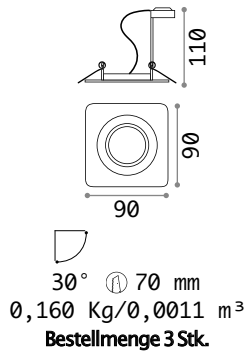

GU10 Nicht inklusive–Empfohlenes Leuchtmittel 108292

Leistung	Ausführ.	Art.-Nr.	€
max 50W	Weiß	138978	17

# Funky

IP20 STAHL

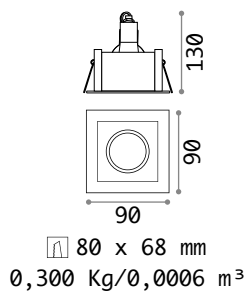

GU10 Nicht inklusive–Empfohlenes Leuchtmittel 108292

Leistung	Ausführ.	Art.-Nr.	€
max 50W	Aluminium	083223	18
	Weiß	083230	18
	Brüniert	083247	18
	Chrom	083193	18
	Schwarz	243849	18



# Room-65

□ IP65 CRI ≥80 50.000 h ALUMINIUM

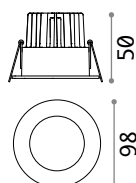

⌀ 68 mm

0,220 Kg/0,0011 m<sup>3</sup>

**LED COB** ON/OFF Transformatorinklusive

Leistung	Beam	Lumen	CCT	Ausführ.	Art-Nr.	€
8W	38°	800 lm	3000 K	Weiß	252025	77
				Schwarz	252032	77

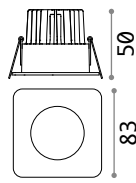

⌀ 68 mm

0,240 Kg/0,0011 m<sup>3</sup>

**LED COB** ON/OFF Transformatorinklusive

Leistung	Beam	Lumen	CCT	Ausführ.	Art-Nr.	€
8W	38°	800 lm	3000 K	Weiß	252049	77
				Schwarz	252056	77



Light beam: ACCENT



# Blues

IP20 GLAS

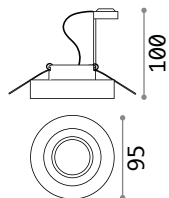

Ø 60 mm  
0,330 Kg/0,0012 m<sup>3</sup>  
Bestellmenge 3 Stk.

**GU10 Nicht inklusive-Empfohlenes Leuchtmittel** 108292

Leistung	Ausführ.	Art.-Nr.	€
max 50W	Transparent	083254	24
	Weiß	113999	24
	Rauchglas	113982	24

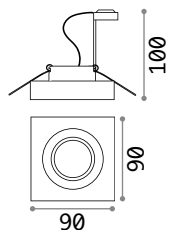

Ø 60 mm  
0,340 Kg/0,0012 m<sup>3</sup>  
Bestellmenge 3 Stk.

**GU10 Nicht inklusive-Empfohlenes Leuchtmittel** 108292

Leistung	Ausführ.	Art.-Nr.	€
max 50W	Transparent	114019	24



# Soul

 IP20 KRISTALL

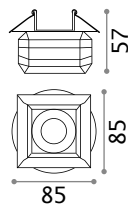

Ⓢ 55 mm

0,340 Kg/0,0009 m<sup>3</sup>

G9 Nicht inklusive-Empfohlenes Leuchtmittel<sup>209043</sup>

Leistung	Ausführ.	Art.-Nr.	€
max 40W	Transparent	107691	20

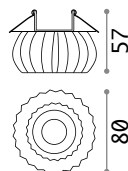

Ⓢ 55 mm

0,400 Kg/0,0008 m<sup>3</sup>

G9 Nicht inklusive-Empfohlenes Leuchtmittel<sup>209043</sup>

Leistung	Ausführ.	Art.-Nr.	€
max 40W	Transparent	107707	20



# Polka

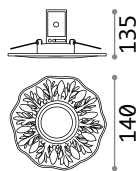

□ ▲ IP20



⌀ 65 mm

0,200 Kg/0,0025 m<sup>3</sup>

**GU10 Nicht inklusive –Empfohlenes Leuchtmittel 108292**

Leistung	Material	Ausführ.	Art-Nr.	€
max 50W	Gips	Weiß	 115597	16
	Aluminium	Messing	 115610	16
	Aluminium	Brüniert	 115580	16



115597



115610



115580



# Walky

IP20 CRI ≥90 50.000h GIPS

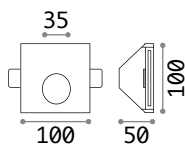

100 x 100mm  
0,580 Kg/0,0009 m<sup>3</sup>

## LED SMD AND DRIVER Inklusive

Leistung	Lumen	CCT	Ausführ.	Art-Nr.	€
1W	55 lm	3000 K	Weiß	249834	63

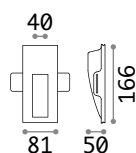

81 x 166 mm  
0,580 Kg/0,0012 m<sup>3</sup>

## LED SMD AND DRIVER Inklusive

Leistung	Lumen	CCT	Ausführ.	Art-Nr.	€
1W	55 lm	3000 K	Weiß	249827	63



Light beam: ASYMMETRICAL





# Leuchtmittel\* und zubehöre



new



E14 846

E27 848



new



G4 854

G9 854



new



new



GX53 855

R7s 855

GU10 856



new



Strip 858

KitEmergency 859



new



new



Ceiling Cups 860











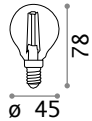

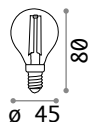

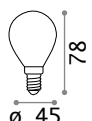

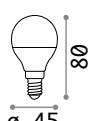
Bulb Holders 864

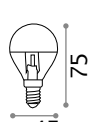
Cables 864

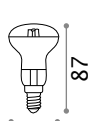
Cables Holders 864

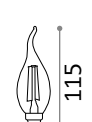
\* Die angegebenen Preise für Glühbirnen und Ledstreifen sind nicht einbegriffen in weiteren Angeboten.

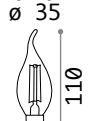
# Leuchtmittel E14

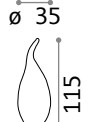
		Lamp socket	Power	Flux	CCT	CRI	Dimmable	Life	Min Qty.	Code	€
		E14	4W	480 lm	3000 K	80		25.000 h	10	101200	3,00
		E14	4W	380 lm	3000 K	80	TRIAC	15.000 h	10	188935	3,90
		E14	4W	520 lm	4000 K	80		25.000 h	10	153926	3,00
		E14	4W	420 lm	3000 K	90		25.000 h	10	271620	3,00
		E14	4W	300 lm	2200 K	80		15.000 h	10	151656	5,50
		E14	4W	420 lm	3000 K	80		25.000 h	10	101217	3,00
		E14	4W	340 lm	3000 K	80	TRIAC	25.000 h	10	289229	3,90
		E14	4W	470 lm	4000 K	80		25.000 h	10	253411	3,00
		E14	4W	340 lm	3000 K	90		25.000 h	10	289212	3,00
		E14	6W	600 lm	3000 K	80		25.000 h	10	151731	3,00
		E14	6W	600 lm	4000 K	80		25.000 h	10	151946	3,00
		E14	4W	370 lm	3000 K	80		25.000 h	10	101262	4,50
		E14	4W	300 lm	3000 K	80		25.000 h	10	101255	4,50
		Lamp socket	Power	Flux	CCT	CRI	Dimmable	Life	Min Qty.	Code	€
		E14	4W	430 lm	3000 K	80		25.000 h	10	101248	3,00
		E14	4W	420 lm	3000 K	80	TRIAC	15.000 h	10	188911	3,90
		E14	4W	460 lm	4000 K	80		25.000 h	10	153940	3,00
		E14	4W	400 lm	2200 K	80		15.000 h	10	151663	5,50
		E14	4W	380 lm	3000 K	80		25.000 h	10	151793	3,00

# Leuchtmittel E14

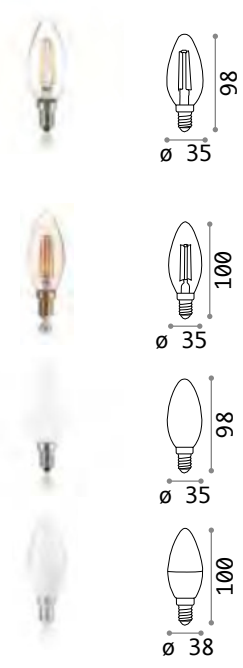

Lamp socket	Power	Flux	CCT	CRI	Dimmable	Life	Min Qty.	Code	€
E14	4W	450 lm	2700 K	80		25.000 h	10	270944	3,00
E14	4W	470 lm	3000 K	80		25.000 h	10	101224	3,00
E14	4W	320 lm	3000 K	80	TRIAC	15.000 h	10	188928	3,90
E14	4W	490 lm	4000 K	80		25.000 h	10	153933	3,00
E14	4W	430 lm	3000 K	90		25.000 h	10	271644	3,00
E14	4W	370 lm	2200 K	80		15.000 h	10	151649	5,50
E14	4W	370 lm	3000 K	80		25.000 h	10	101231	3,00
E14	6W	520 lm	3000 K	80		25.000 h	10	151748	3,00
E14	6W	520 lm	4000 K	80		25.000 h	10	151953	3,00



151663      151793







101224      151649      101231

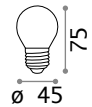

101200      101262

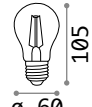
# Leuchtmittel E27

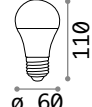
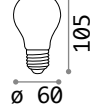
		Lamp socket	Power	Flux	CCT	CRI	Dimmable	Life	Min Qty.	Code	€
		E27	4W	490 lm	2700 K	80		25.000 h	10	271637	3,00
		E27	4W	430 lm	3000 K	80		25.000 h	10	101279	3,00
		E27	4W	340 lm	3000 K	80	TRIAC	15.000 h	10	188942	3,00
		E27	4W	490 lm	4000 K	80		25.000 h	10	153957	3,00
		E27	4W	350 lm	3000 K	90		25.000 h	10	289236	3,00
		E27	4W	380 lm	2200 K	80		15.000 h	10	151861	5,50
		E27	4W	340 lm	3000 K	80		25.000 h	10	101286	3,00
		E27	6W	600 lm	3000 K	80		25.000 h	10	151755	2,50
		E27	6W	600 lm	4000 K	80		25.000 h	10	151960	2,50
		E27	4W	480 lm	3000 K	80		25.000 h	10	101293	3,00
		E27	4W	520 lm	4000 K	80		25.000 h	10	253428	3,00
		E27	8W	930 lm	2700 K	80		25.000 h	10	270951	7,00
		E27	8W	910 lm	3000 K	80		25.000 h	10	119571	7,00
		E27	8W	680 lm	3000 K	80	TRIAC	15.000 h	10	188973	7,50
		E27	8W	980 lm	4000 K	80		25.000 h	10	153964	7,00
		E27	8W	880 lm	3000 K	90		25.000 h	10	271613	7,00
		E27	10W	1300 lm	3000 K	80		25.000 h	10	256528	7,00
		E27	10W	1380 lm	4000 K	80		25.000 h	10	270920	7,00
		E27	4W	370 lm	2200 K	80		15.000 h	10	151687	5,50
		E27	8W	900 lm	3000 K	80		25.000 h	10	123899	7,00
		E27	8W	860 lm	3000 K	80	TRIAC	25.000 h	10	252209	7,50
		E27	8W	1030 lm	4000 K	80		25.000 h	10	253459	7,00
		E27	8W	780 lm	3000 K	90		25.000 h	10	289250	7,50
		E27	10W	1000 lm	3000 K	80		25.000 h	10	151762	2,50
		E27	10W	1000 lm	4000 K	80		25.000 h	10	151991	2,50
		E27	8W	920 lm	3000 K	80		25.000 h	10	305622	7,50 new
		E27	10W	1150 lm	3000 K	80		25.000 h	10	305639	7,00 new

# Leuchtmittel E27

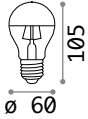

Lamp socket	Power	Flux	CCT	CRI	Dimmable	Life	Min Qty.	Code	€
E27	8W	770lm	3000 K	80		25.000 h	10	123882	7,50

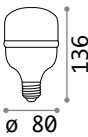

Lamp socket	Power	Flux	CCT	CRI	Dimmable	Life	Min Qty.	Code	€
E27	20W	2000lm	3000 K	80		25.000 h	1	296197	6,00 <i>new</i>
E27	20W	2050lm	4000 K	80		25.000 h	1	306889	6,00 <i>new</i>

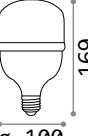

E27	30W	3100lm	3000 K	80		25.000 h	1	296210	11,00 <i>new</i>
E27	30W	3200lm	4000 K	80		25.000 h	1	306896	11,00 <i>new</i>



296197



296210



101279



151861















101293



123882

# Leuchtmittel E27

	Lamp socket	Power	Flux	CCT	CRI	Dimmable	Life	Min Qty.	Code	€
	E27	8W	1120lm	3000K	80		25.000 h	10	101323	7,50
	E27	8W	680 lm	3000 K	80	TRIAC	15.000 h	10	188966	8,50
	E27	8W	1120lm	4000 K	80		25.000 h	10	153971	7,50
	E27	8W	860 lm	3000 K	90		25.000 h	10	271606	7,50
	E27	4W	500 lm	2200 K	80		15.000 h	10	151717	8,90
	E27	4W	330 lm	2200 K	80	TRIAC	15.000 h	10	223933	7,50
	E27	8W	950 lm	3000 K	80		25.000 h	10	101330	8,00
	E27	8W	860 lm	3000 K	80	TRIAC	25.000 h	10	252186	8,50
	E27	8W	1050lm	4000 K	80		25.000 h	10	253442	8,00
	E27	8W	770lm	3000 K	90		25.000 h	10	289243	8,00
	E27	15W	1820lm	3000 K	80		25.000 h	10	151779	5,50
	E27	15W	1820lm	4000 K	80		25.000 h	10	151977	5,50
	E27	8W	900 lm	3000 K	80	TRIAC	15.000 h	10	277790	10,50 <small>new</small>
	E27	8W	1050lm	3000 K	80		25.000 h	10	157597	10,50
	E27	9W	930 lm	3000 K	80		25.000 h	10	135526	10,50



101330



157597



135526

# Leuchtmittel E27



Lamp socket	Power	Flux	CCT	CRI	Dimmable	Life	Min Qty.	Code	€
E27	8W	1020lm	3000K	80		25.000 h	10	101347	8,50
E27	8W	680 lm	3000K	80	TRIAC	15.000 h	10	188959	9,00
E27	8W	1070lm	4000K	80		25.000 h	10	153988	8,50
E27	8W	860 lm	3000K	90		25.000 h	10	271590	8,50
E27	4W	480 lm	2200K	80		15.000 h	10	151724	8,50
E27	4W	330 lm	2200K	80	TRIAC	15.000 h	10	223926	9,50
E27	8W	900 lm	3000K	80		25.000 h	10	101354	8,50
E27	8W	1030lm	4000K	80		25.000 h	10	253435	8,50
E27	18W	2180lm	3000K	80		25.000 h	10	151786	8,00
E27	18W	2180lm	4000K	80		25.000 h	10	152004	8,00
E27	8W	900 lm	3000K	80	TRIAC	15.000 h	10	277813	11,00 new
E27	8W	1050lm	3000K	80		25.000 h	10	157580	11,00



101347











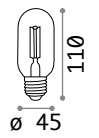

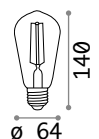

151724

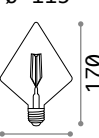

277813

# Leuchtmittel E27

	Lamp socket	Power	Flux	CCT	CRI	Dimmable	Life	Min Qty.	Code	€
		E27	4 W	330 lm	2200 K	80	15.000 h	10	151700	5,50
		E27	4 W	440 lm	2200 K	80	15.000 h	10	151694	7,00
		E27	4 W	330 lm	2200 K	80	TRIAC	15.000 h	223919	7,00
		E27	4 W	340 lm	1800 K	80	15.000 h	10	201283	5,90
		E27	4 W	340 lm	1800 K	80	15.000 h	10	201269	11,00
		E27	4 W	340 lm	1800 K	80	15.000 h	10	201290	12,50
		E27	4 W	340 lm	1800 K	80	15.000 h	10	201276	12,50



151700

151694

201283









201269

201290

201276



# Leuchtmittel E27

	Lamp socket	Power	Flux	CCT	CRI	Dimmable	Life	Min Qty.	Code	€
	E27	6W	500 lm	1800K	80		15.000 h	10	201252	11,00
	E27	4W	320 lm	2200K	80		15.000 h	1	130170	35,00
	E27	4W	320 lm	2200K	80		15.000 h	1	129877	30,00
	E27	4W	330 lm	2200K	80	TRIAC	15.000 h	1	223940	30,00
	E27	4W	400 lm	2200K	80		25.000 h	1	130187	30,00
	E27	4W	330 lm	2200K	80	TRIAC	15.000 h	1	223834	35,00
	E27	4W	360 lm	2200K	80		25.000 h	1	237251	25,00
	E27	8W	700 lm	2200K	80		25.000 h	1	130163	30,00
	E27	4W	320 lm	2200K	80		15.000 h	1	129860	35,00

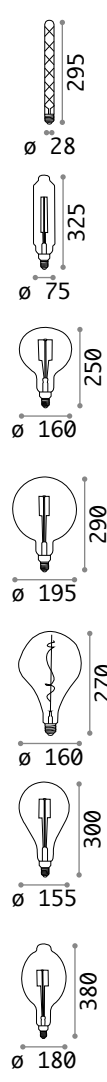

# Leuchtmittel G4

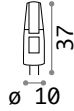
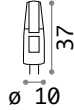

Lamp socket	Power	Flux	CCT	CRI	Dimmable	Life	Min Qty.	Code	€
G4	1,5W	160lm	3000 K	80		15.000 h	20	188980	6,00
G4	1,5W	150lm	3000 K	90		15.000 h	20	288345	6,00
G4	2 W	160lm	3000 K	80		20.000 h	20	222257	4,50
G4	2 W	180lm	3000 K	80	Phase-cut	25.000 h	20	266282	6,90

# Leuchtmittel G9

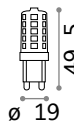
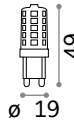
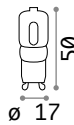

Lamp socket	Power	Flux	CCT	CRI	Dimmable	Life	Min Qty.	Code	€
G9	2 W	150lm	3000 K	80		25.000 h	20	270104	8,90
G9	2 W	150lm	4000 K	80		25.000 h	20	270111	8,90
G9	2,5 W	200 lm	3000 K	80		20.000 h	20	122168	3,00
G9	2,5 W	210lm	4000 K	80		20.000 h	20	253381	3,00
G9	3 W	350 lm	2700 K	80		15.000 h	20	270968	3,90
G9	3 W	370lm	3000 K	80		15.000 h	20	209043	3,90
G9	3 W	260 lm	3000 K	80	TRIAC	25.000 h	20	288215	5,50
G9	3 W	390 lm	4000 K	80		15.000 h	20	209036	3,90
G9	3,5 W	310lm	3000 K	90		15.000 h	20	288208	3,90
G9	3,5 W	510lm	3000 K	80		15.000 h	20	305486	6,00 new
G9	3,5 W	420 lm	3000 K	80	TRIAC	15.000 h	20	305431	8,50 new
G9	4 W	530 lm	4000 K	80		15.000 h	20	307879	6,00 new
G9	4 W	440 lm	4000 K	80	TRIAC	15.000 h	20	307886	8,50 new

# Leuchtmittel GX53

101385

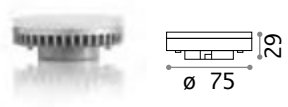
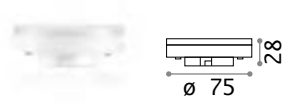

Lamp socket	Power	Flux	CCT	CRI	Dimmable	Life	Min Qty.	Code	€
GX53	7W	600 lm	3000 K	80		25.000 h	10	101385	6,70
GX53	7W	610lm	4000 K	80		25.000 h	10	253404	6,70
GX53	9W	910lm	3000 K	80		25.000 h	10	123936	6,00
GX53	9W	890 lm	3000 K	80	TRIAC	25.000 h	10	252551	9,50
GX53	9W	1000lm	4000 K	80		25.000 h	10	154008	6,00
GX53	9W	900 lm	4000 K	80	TRIAC	25.000 h	10	252568	9,50
GX53	9W	940 lm	3000 K	90		25.000 h	10	288383	6,00





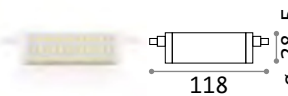
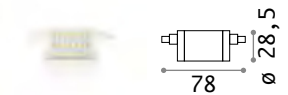
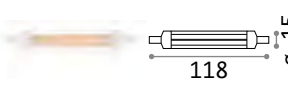

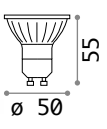

# Leuchtmittel R7s

189109

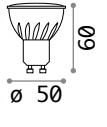

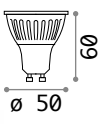
Lamp socket	Power	Flux	CCT	CRI	Dimmable	Life	Min Qty.	Code	€
R7s	7W	560 lm	3000 K	80		20.000 h	10	189109	14,50
R7s	6W	450 lm	3000 K	80	TRIAC	20.000 h	10	266770	15,50
R7s	7W	580 lm	4000 K	80		20.000 h	10	272375	14,50
R7s	6W	480 lm	4000 K	80	TRIAC	20.000 h	10	272382	15,50
R7s	13W	760lm	3000 K	80		20.000 h	10	189093	18,50
R7s	8W	580 lm	3000 K	80	TRIAC	20.000 h	10	266763	20,00
R7s	13W	830 lm	4000 K	80		20.000 h	10	253480	18,50
R7s	8W	640 lm	4000 K	80	TRIAC	20.000 h	10	266756	20,00
R7s	8W	1000lm	3000 K	80		15.000 h	10	299310	11,50 new
R7s	8W	850 lm	3000 K	80	TRIAC	15.000 h	10	299303	12,50 new
R7s	8W	1000lm	4000 K	80		15.000 h	10	307633	11,50 new
R7s	8W	900 lm	4000 K	80	TRIAC	15.000 h	10	307640	12,50 new
R7s	14W	1700lm	3000 K	80		15.000 h	10	307862	13,50 new
R7s	14W	1600lm	3000 K	80	TRIAC	15.000 h	10	307855	15,00 new
R7s	14W	1700lm	4000 K	80		15.000 h	10	296869	13,50 new
R7s	14W	1650lm	4000 K	80	TRIAC	15.000 h	10	296876	15,00 new

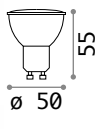
# Leuchtmittel GU10

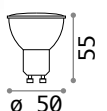
	Lamp socket	Power	Flux	CCT	CRI	Beam	Dimm.	Life	Min Qty.	Code	€
 	GU10	5 W	440 lm	3000 K	90	47°		25.000 h	10	108292	4,50
	GU10	5 W	390 lm	3000 K	90	47°	TRIAC	25.000h	10	266251	4,50
	GU10	5 W	500 lm	4000 K	90	47°		25.000 h	10	253497	4,50
	GU10	5 W	420 lm	4000 K	90	47°	TRIAC	25.000h	10	285566	4,50
	GU10	7W	610lm	3000 K	90	50°		25.000 h	10	123943	4,50
	GU10	7W	540 lm	3000 K	90	50°	TRIAC	25.000h	10	288239	5,90
	GU10	7W	700 lm	4000 K	90	50°		25.000 h	10	224367	4,50
	GU10	7W	530 lm	3000 K	90	50°		25.000 h	10	288222	9,00
 	GU10	7W	690 lm	3000 K	90	108°		25.000 h	10	101378	9,00
	GU10	7W	770lm	4000 K	90	108°		30.000 h	10	117652	9,00
 	GU10	8W	760 lm	3000 K	90	54°		25.000 h	10	189062	9,00
	GU10	8W	880 lm	4000 K	90	54°		25.000 h	10	270975	9,00
 	GU10	5 W	380 lm	2700 K	95	47°		25.000 h	10	307619	4,50 new
 	GU10	7W	600 lm	2700 K	95	107°		25.000 h	10	307626	4,50 new



108292



101378



189062

# Leuchtmittel GU10

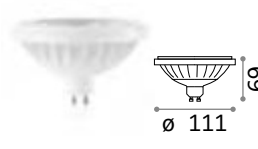
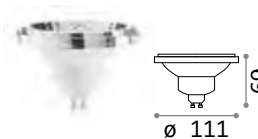
	Lamp socket	Power	Flux	CCT	CRI	Beam	Dimm.	Life	Min Qty.	Code	€
	GU10	12W	960 lm	3000 K	80	23°		25.000 h	10	242040	14,50
	GU10	12W	900 lm	3000 K	80	23°	TRIAC	25.000h	10	266305	16,00
	GU10	12W	1190lm	4000 K	80	23°		25.000 h	10	285573	14,50
	GU10	12W	1120lm	3000 K	80	46°		25.000 h	10	183794	14,50
	GU10	12W	1240lm	4000 K	80	46°		25.000 h	10	253466	14,50
	GU10	13W	1300lm	3000 K	80	46°	TRIAC	25.000h	10	266299	18,50
	GU10	10W	800 lm	3000 K	80	20°		15.000 h	10	189031	15,00
	GU10	10W	820 lm	4000 K	80	20°		15.000 h	10	253398	15,00
	GU10	10W	800 lm	3000 K	80	24°	TRIAC	15.000h	10	288543	19,00



242040



183794



189031

# Strip LED and Drivers

Volt 24Vdc  
 MacAdam SDCM 3  
 Beam 120°  
 LED life 35.000 h

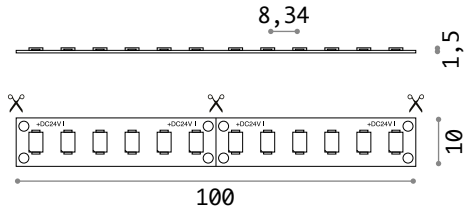

SMD 2835 120LED/m CRI ≥90

Power	IP	Flux	CCT	Length	Code	€
15W/m	IP20	1400 lm/m	2700 K	5000 mm	272498	50
		1450 lm/m	3000 K	5000 mm	272481	50
		1600 lm/m	4000 K	5000 mm	272474	50
		1400 lm/m	3000 K	5000 mm	272504	65
	IP65	1480 lm/m	4000 K	5000 mm	287959	65

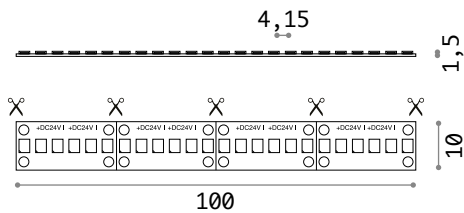

SMD 2835 240LED/m CRI ≥90

Power	IP	Flux	CCT	Length	Code	€
20,5 W/m	IP20	2000 lm/m	2700 K	5000 mm	272535	80
		2050 lm/m	3000 K	5000 mm	272528	80
		2100 lm/m	4000 K	5000 mm	272511	80
		2000 lm/m	3000 K	5000 mm	272542	90
	IP65	2020 lm/m	4000 K	5000 mm	287966	90

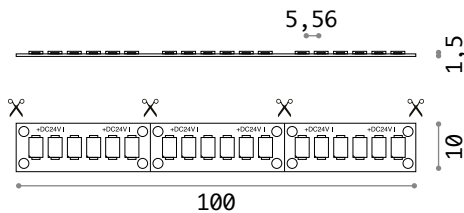

SMD 2835 180LED/m CRI ≥90

Power	IP	Flux	CCT	Length	Code	€
40 W/m	IP20	3370 lm/m	3000 K	3000 mm	253886	120
		3730 lm/m	4000 K	3000 mm	253893	120



Required	Code	€
No -Optional	292939	1 new
No -Optional	292953	1 new



Nur für Innen-Installationen geeignet



Driver	Power	Output	Class	Measure (L xH xW)	Code	€
On-Off	30 W	24 Vdc	□	140x28 x 45 mm	124070	17,50
	60 W	24 Vdc	□	186x33 x 50 mm	124087	30
	150 W	24 Vdc	⊕	268 x 31x 45 mm	124117	50
1-10V/Push	36 W	24 Vdc	□	293 x 30x 43 mm	244556	60
	75 W	24 Vdc	⊕	293 x 30 x 43 mm	244570	100
	150 W	24 Vdc	⊕	352 x 30x 43 mm	244594	140
DALI/Push	36 W	24 Vdc	□	175x30 x 44 mm	244549	75
	75 W	24 Vdc	⊕	295 x 30 x 43 mm	244563	115
	150 W	24 Vdc	⊕	273 x 37 x 57 mm	244587	150

## Kit emergency

EmergencyKit für LED Module.  
 Inverter und Batterie inklusive.  
 Betriebsdauer von 2 bis 3 Stunden  
 mit 12, bzw. 24 Stunden Ladezeit.  
 Betrieb als Not- oder Dauerlicht  
 (Dauerlicht mit elektronischen  
 Vorschaltgeräten und dimmbaren  
 elektronischen Vorschaltgeräten).  
 Schutzklasse II.



INVERTER

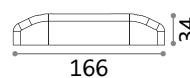

□ IP20

0,185Kg /0,0009 m3

⊕ 52 mm

GROUP BATTERY

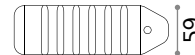
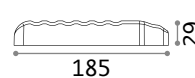

0,305 Kg /0,0010 m3

⊕ 65 mm

€ 120

221595 Weiß

Für zusätzliche Informationen, bitte Kontakt mit der technischen Abteilung aufnehmen.

# Baldachine

## Magnetische Baldachine

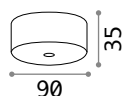

1Kabel

				
244235 € 16,00	244259 € 16,00	249315 € 19,00	249308 € 19,00	244242 € 16,00

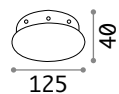

6 Kabel

				
303390 € 25,00 <sup>new</sup>	303406 € 25,00 <sup>new</sup>	307091 € 35,00 <sup>new</sup>	307084 € 35,00 <sup>new</sup>	307077 € 25,00 <sup>new</sup>

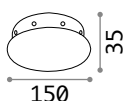

8 Kabel

				
272429 € 30,00	272436 € 30,00	272443 € 41,00	272450 € 41,00	272467 € 30,00

## Einbau Baldachine

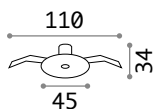

1Kabel

				
301594 € 5,00 <sup>new</sup>	307107 € 5,00 <sup>new</sup>	307138 € 5,00 <sup>new</sup>	307121 € 5,00 <sup>new</sup>	307114 € 5,00 <sup>new</sup>



# Baldachine

## Standart-Baldachine

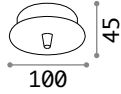

1Kabel

				
122823 € 8,00	122830 € 8,00	249278 € 9,00	249261 € 9,00	123295 € 8,00

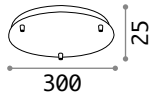

3 Kabel

				
285580 € 50,00	285597 € 50,00	285627 € 72,00	285610 € 72,00	285603 € 50,00

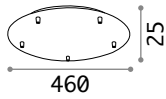

5 Kabel

				
285634 € 83,00	285641 € 83,00	285672 € 110,00	285665 € 110,00	285658 € 83,00

## Lineare Baldachine

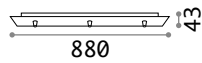

3 Kabel

				
122854 € 39,00	122861 € 39,00	249292 € 44,00	249285 € 44,00	123301 € 39,00

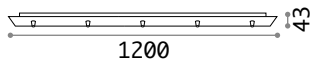

5 Kabel

				
285689 € 61,00	285696 € 61,00	285726 € 77,00	285719 € 77,00	285702 € 61,00

# Baldachine

All in Baldachine

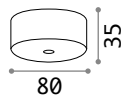

3 Kabel

				
285733 € 28,00	285740 € 28,00	285771 € 33,00	285764 € 33,00	285757 € 28,00

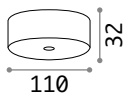

6 Kabel

				
285788 € 33,00	285795 € 33,00	285825 € 44,00	285818 € 44,00	285801 € 33,00

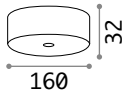

12Kabel

				
285832 € 50,00	285849 € 50,00	285870 € 60,00	285863 € 60,00	285856 € 50,00



# Zubehöre

## Leuchtmittel-Fassung

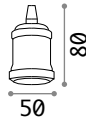

				
249186 € 15,00	249193 € 15,00	249223 € 15,00	249216 € 15,00	249209 € 15,00

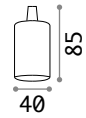

				
242569 € 7,50	249230 € 7,50	249254 € 7,50	249247 € 7,50	242576 € 7,50

## Kabel

Ø 5 x 5000 mm  
2 x 0,75 mm<sup>2</sup>  
FEP T180°  
PVC T90°  
\*only PVC

				
301624 € 16,00 <sup>new</sup>	301662* € 16,00 <sup>new</sup>	301655 € 16,00 <sup>new</sup>	301648 € 16,00 <sup>new</sup>	301631 € 16,00 <sup>new</sup>

Ø 5 x 10000 mm  
2 x 0,75 mm<sup>2</sup>  
FEP T180°  
PVC T90°  
\*only PVC

				
301679 € 25,00 <sup>new</sup>	301716* € 25,00 <sup>new</sup>	301709 € 25,00 <sup>new</sup>	301693 € 25,00 <sup>new</sup>	301686 € 25,00 <sup>new</sup>

Ø 5 x 10000 mm  
2 x 0,75 mm<sup>2</sup>  
FEP T180°  
PVC T90°

				
303062 € 30,00 <sup>new</sup>	306421 € 30,00 <sup>new</sup>	303093 € 30,00 <sup>new</sup>	303086 € 30,00 <sup>new</sup>	303079 € 30,00 <sup>new</sup>

## Halterungen



				
143200 € 7,00	143224 € 7,00	249339 € 7,00	249322 € 7,00	143217 € 7,00



				
285887 € 7,00	285894 € 7,00	285924 € 7,00	285917 € 7,00	285900 € 7,00

edelux  
edelux

Qualität Innovation Design